



**TIM LINDEN**

---

**ASTROPHYSICAL SIGNATURES OF DARK  
MATTER ACCUMULATION IN NEUTRON STARS**

**Towards Dark Matter Discovery Workshop**



**THE OHIO STATE UNIVERSITY**

---

CENTER FOR COSMOLOGY AND  
ASTROPARTICLE PHYSICS

**April 11, 2018**





**TIM LINDEN**

---

**WITH JOSEPH BRAMANTE, MASHA BARYAKHTAR,  
SHIRLEY LI, NIRMAL RAJ, YU-DAI TSAI**

**Towards Dark Matter Discovery Workshop**



**THE OHIO STATE UNIVERSITY**

---

CENTER FOR COSMOLOGY AND  
ASTROPARTICLE PHYSICS

**April 11, 2018**



# DARK MATTER DIRECT DETECTION

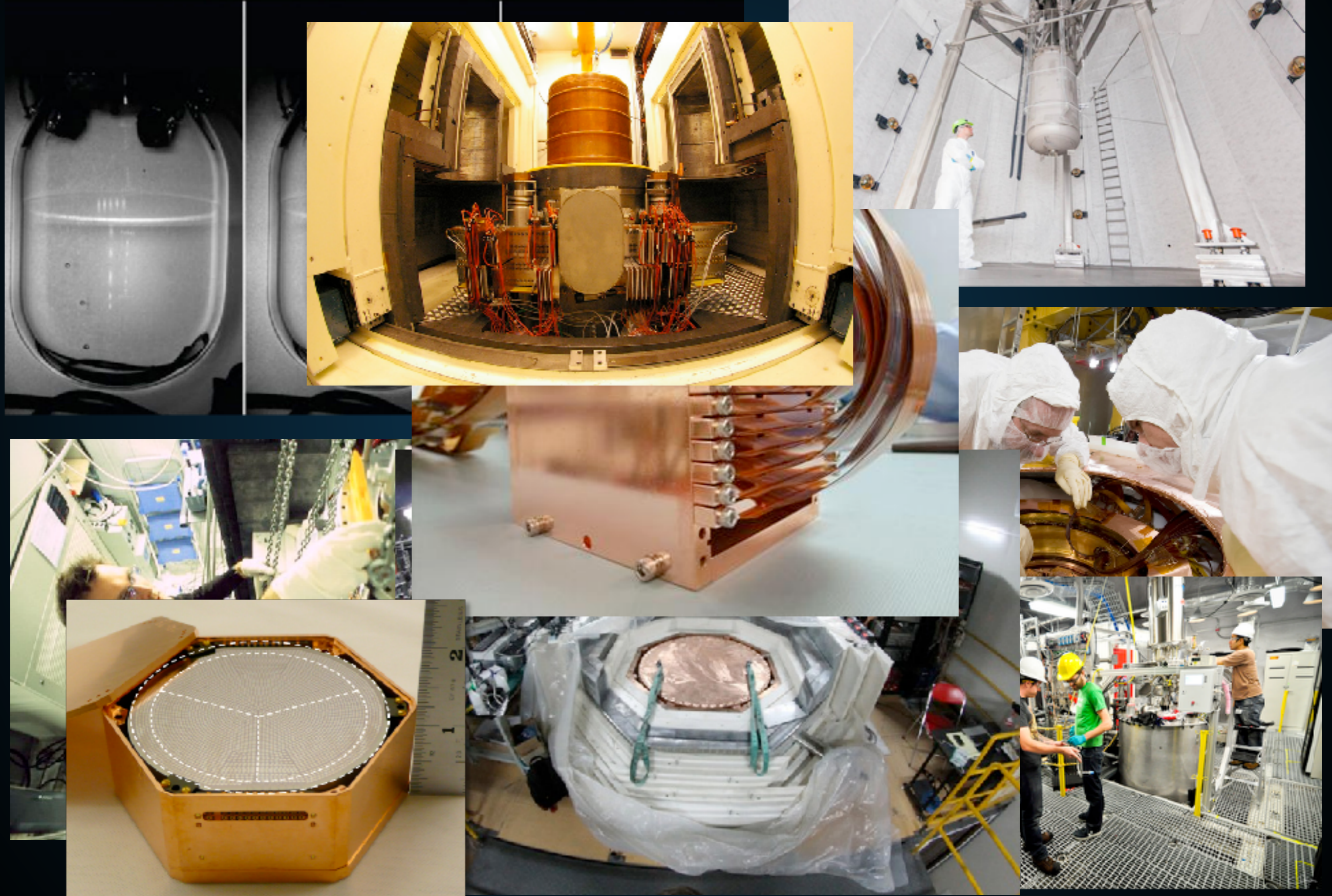



# DARK MATTER DIRECT DETECTION

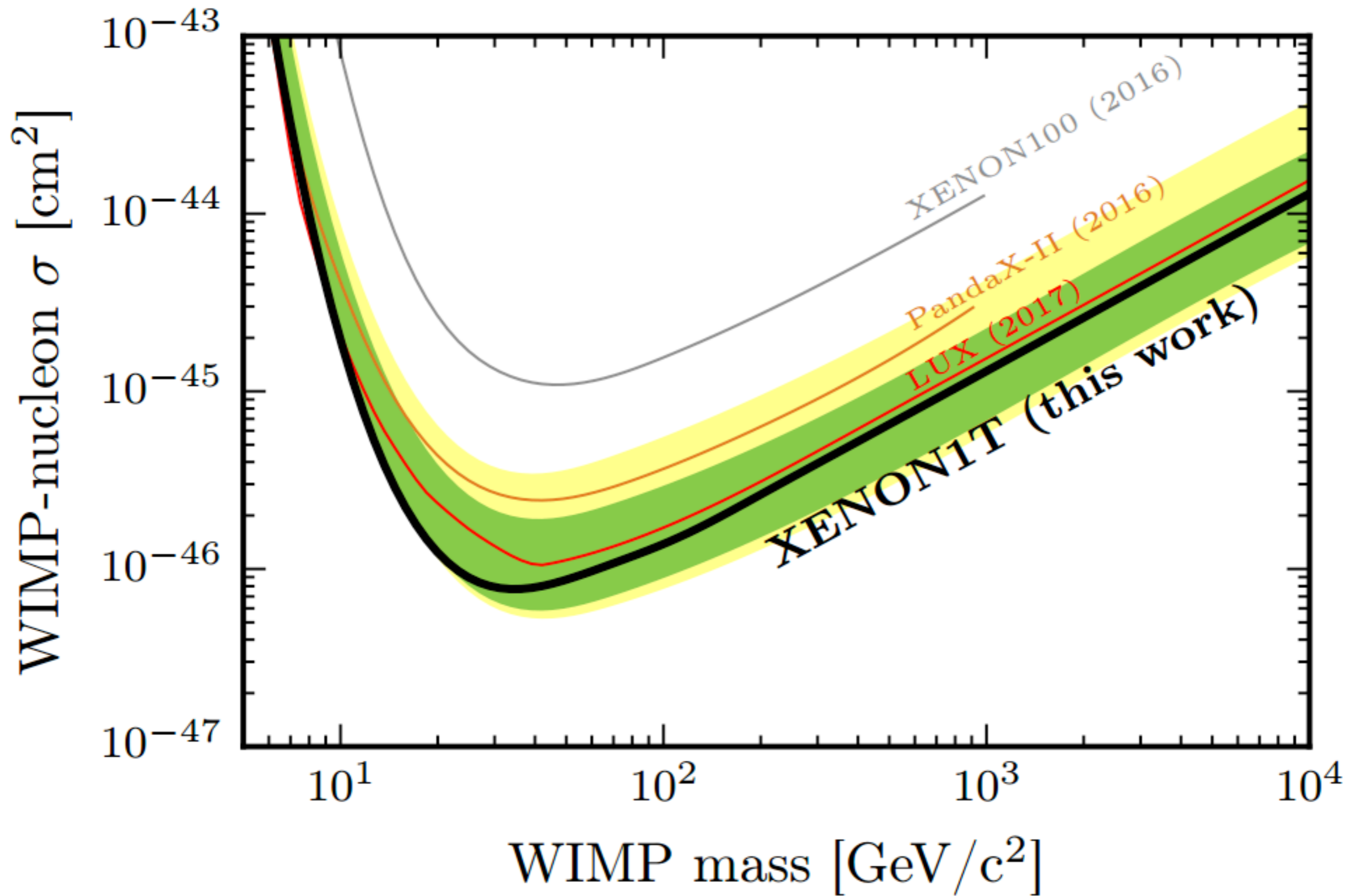



# NEUTRON STARS AS DIRECT DETECTION LABORATORIES



- ▶ **Xenon1T**
  - ▶ **1000 kg**
  - ▶ **730 day**
  - ▶  **$7.3 \times 10^5$  kg day**

- ▶ **Neutron Star**
  - ▶  **$2.8 \times 10^{30}$  kg**
  - ▶  **$1.8 \times 10^{10}$  day**
  - ▶  **$5.0 \times 10^{40}$  kg day**

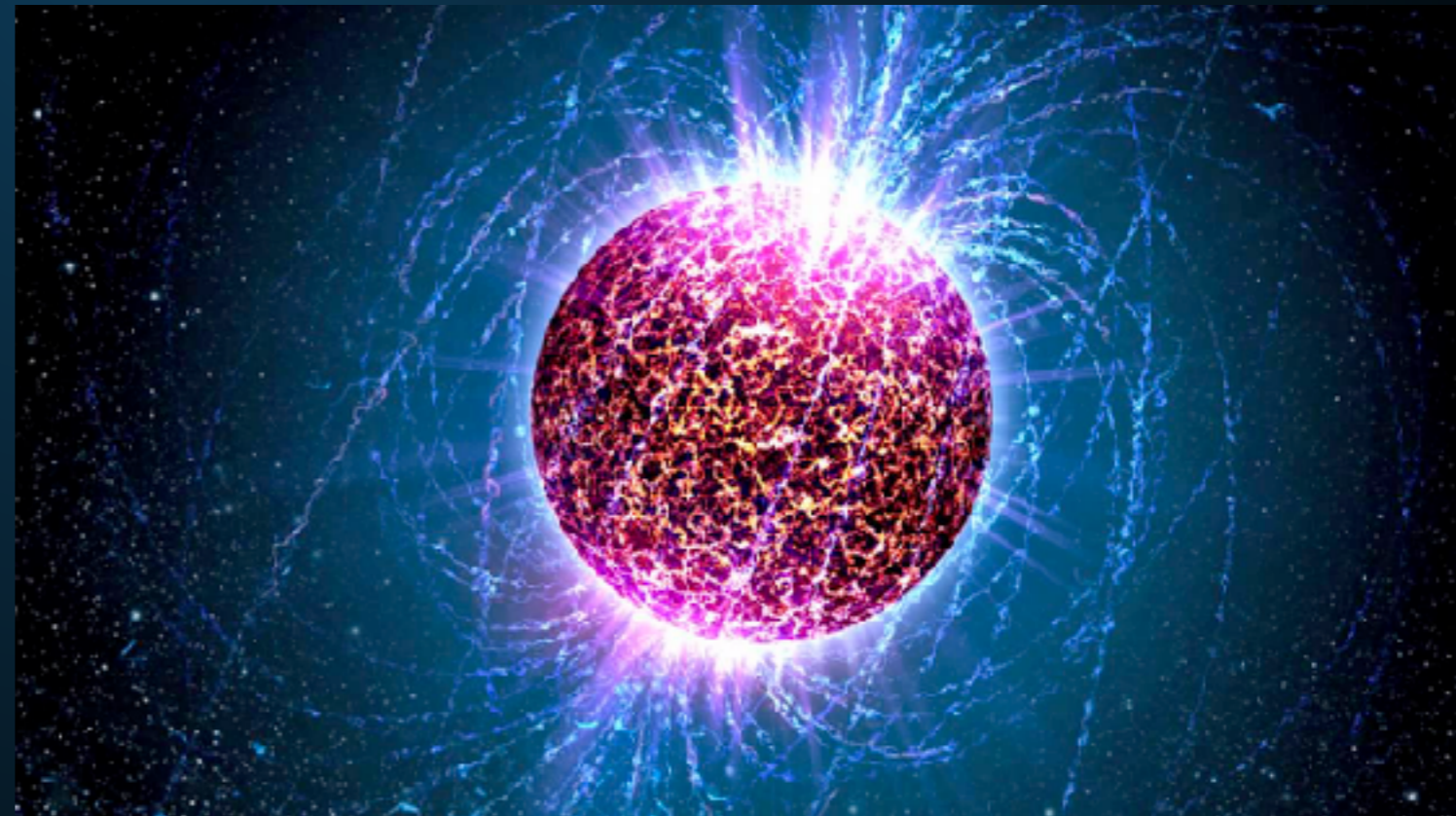



## NEUTRON STARS AS DIRECT DETECTION LABORATORIES

---

- ▶ **Neutron stars are sensitive to very small interaction cross-sections:**

$$\sigma_{\text{sat}}^{\text{single}} \simeq \pi R^2 m_n / M \simeq 2 \times 10^{-45} \text{ cm}^2 \left( \frac{1.5 M_{\odot}}{M} \right) \left( \frac{R}{10 \text{ km}} \right)^2$$

- ▶ **This saturates the sensitivity of neutron stars as dark matter detectors. Do not get additional sensitivity to higher cross-sections (in general).**



# NEUTRON STARS AS DIRECT DETECTION LABORATORIES

---

**Goal:** Become sensitive to single dark matter nucleon scattering events in an energetic  $1 M_{\odot}$  neutron star that is 300 light years away.



# NEUTRON STARS AS DIRECT DETECTION LABORATORIES

---

**Reasonable Goal:** Produce observations that would be sensitive to  $\sim 10^{35}$  dark matter neutron star interactions over the history of the universe.



# CONVERTING PARTICLE INTERACTIONS INTO ASTROPHYSICS!

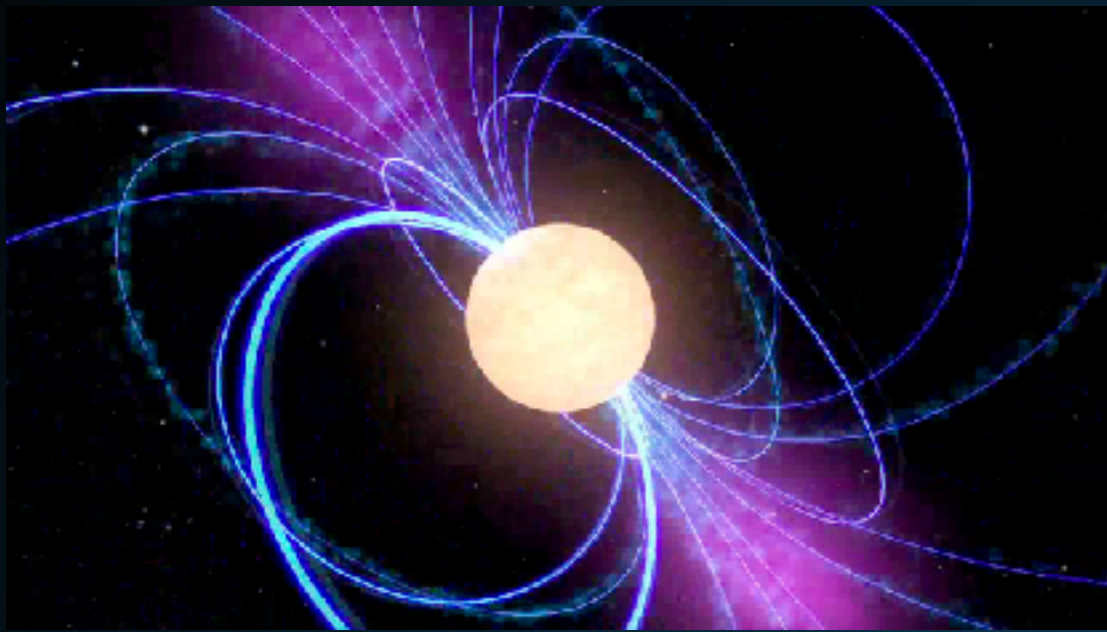

- ▶ **Pulsars = Quickly rotating NS with strong B-fields**
- ▶ **Rotation slows due to dipole radiation, which is visible.**
- ▶ **A Precision Detector:**

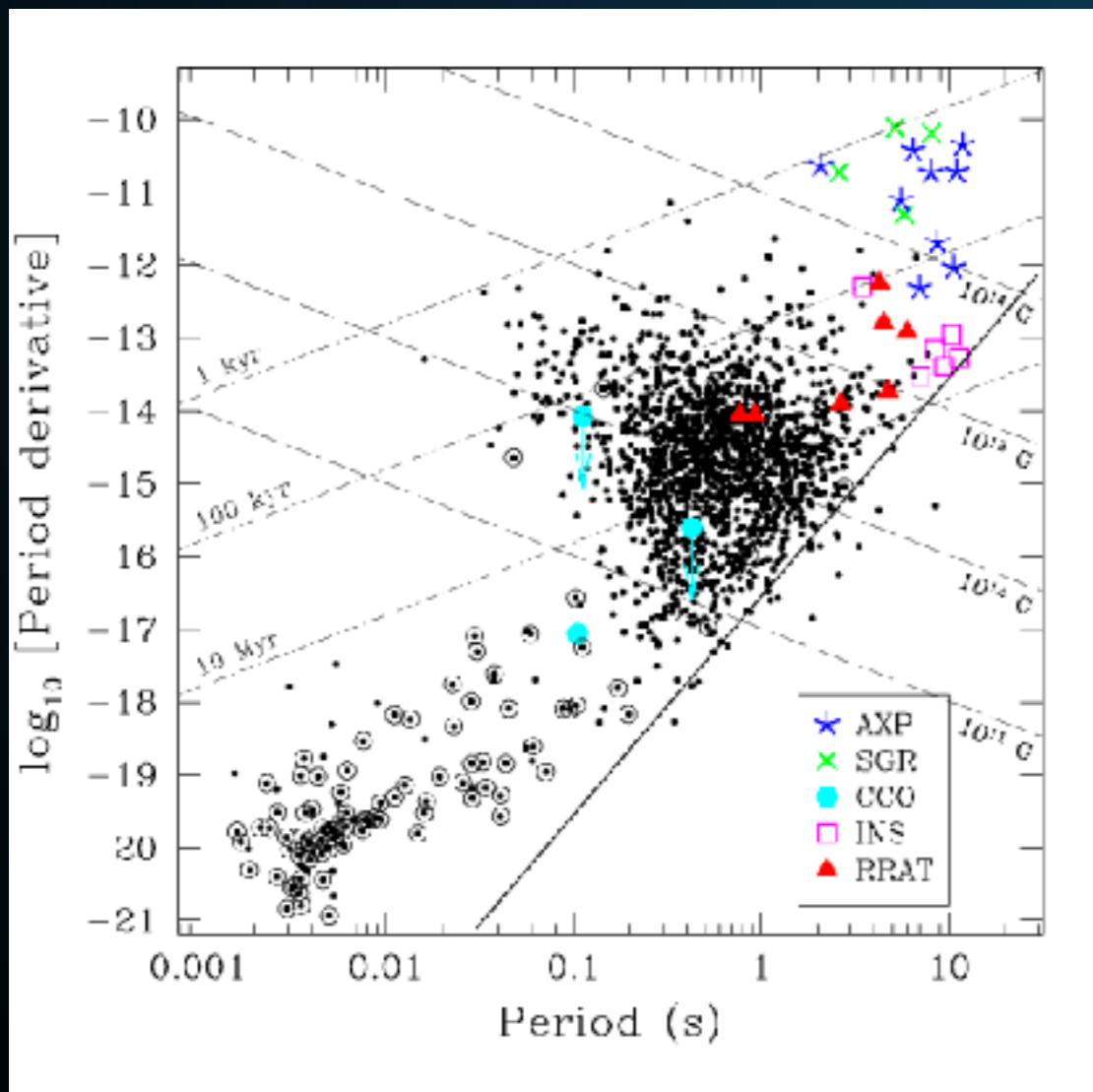

- ▶ **Age**
- ▶ **Spin-down power**
- ▶ **Distance (dispersion)**
- ▶ **Masses**

$$\tau \approx P / (2\dot{P})$$



---

# **The Physics Required to Convert Particle Physics Interactions into Astronomical Observables**



# DARK MATTER ACCUMULATION IN NEUTRON STARS

---

## ▶ Three Stages of Dark Matter Accumulation:

### ▶ Dark Matter **Capture**

- ▶ DM hits neutron and elastically scatters

### ▶ Dark Matter **Thermalization**

- ▶ Trapped dark matter interacts with nucleon fluid and achieves temperature equilibrium.

### ▶ Dark Matter **Collapse**

- ▶ Dark matter degeneracy pressure not capable of preventing collapse.

## STAGE I: CAPTURE: ASTROPHYSICAL ENHANCEMENTS

- ▶ Two enhancements:
  - ▶ NS gravitational potential well
  - ▶ Regions with high dark matter density

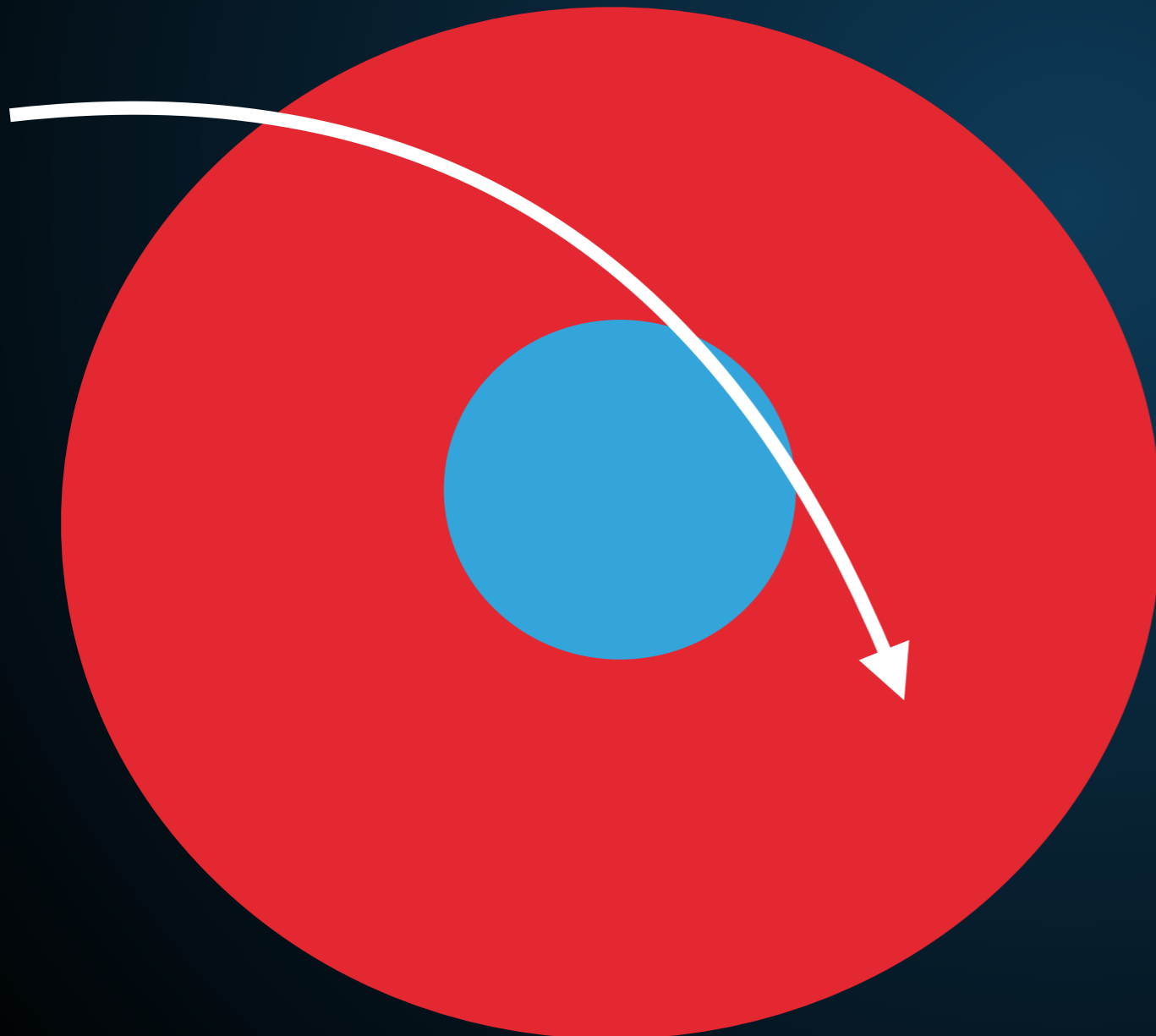

Potential well moves slowly moving dark matter particles into collisional orbit.

Interaction rate scales as  $v_x^{-1}$ .

$$b_{\max} = \left( \frac{2GM R}{v_x^2} \right)^{1/2} \left( 1 - \frac{2GM}{R} \right)^{-1/2}$$

$$\dot{m} = \pi b_{\max}^2 v_x \rho_x,$$



- ▶ Two enhancements:
  - ▶ NS gravitational potential well
  - ▶ Regions with high dark matter density

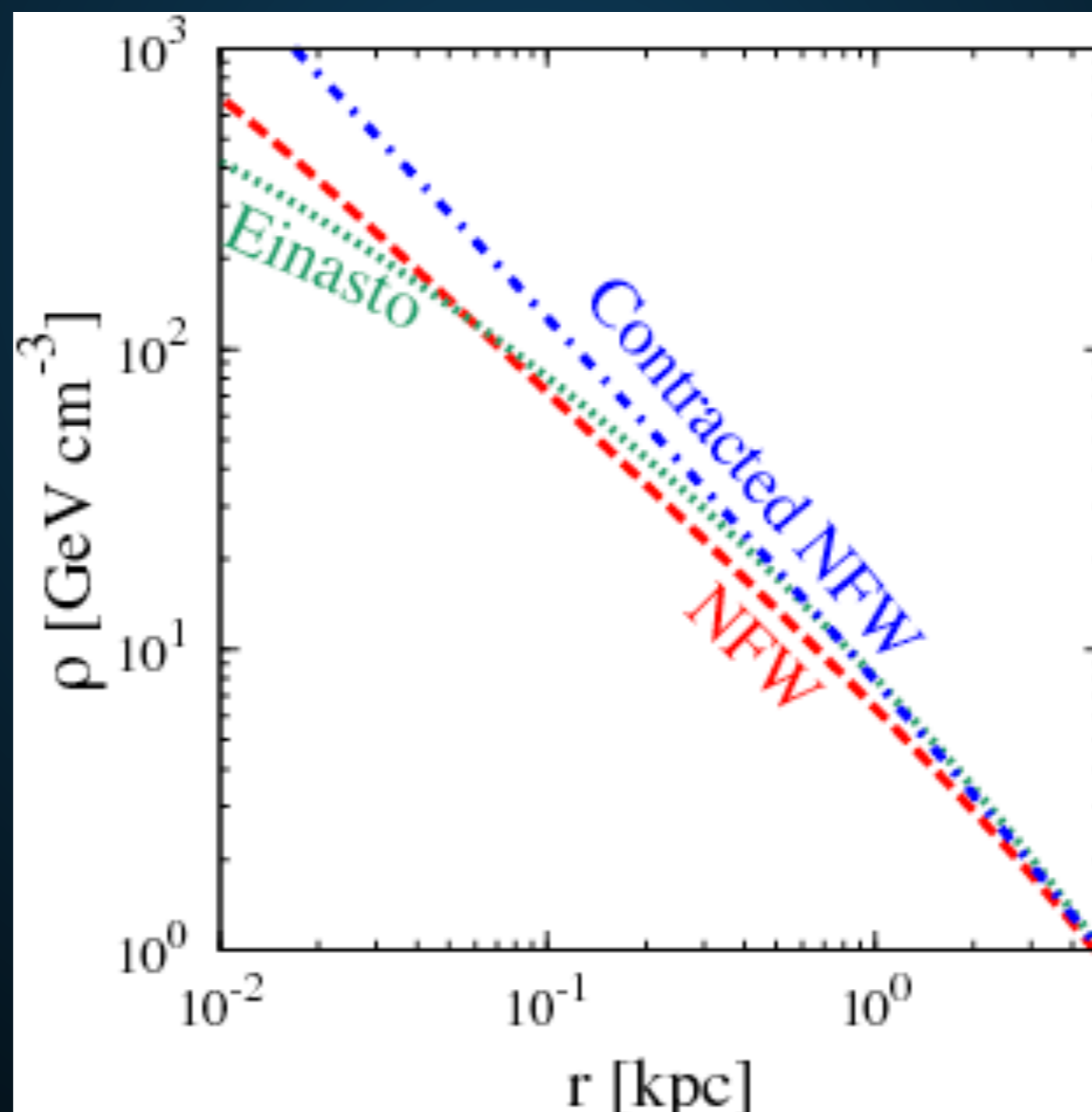

## STAGE I: CAPTURE: PARTICLE PHYSICS ENHANCEMENTS

---

- ▶ **Two enhancements:**
  - ▶ **Interactions are relativistic (p-wave)**
  - ▶ **Spin-Dependent Interactions**

**Neutron Stars are a dark matter collider:**

$$v_{esc} = \sqrt{\frac{2GM}{r}} \sim 0.7c$$

**Dark Matter interacts with a neutron star relativistically**

**Can probe p-wave suppressed or mass-split (e.g. Higgsino) DM**



## **STAGE I: CAPTURE: PARTICLE PHYSICS ENHANCEMENTS**

---

- ▶ **Two enhancements:**
  - ▶ **Interactions are relativistic (p-wave)**
  - ▶ **Spin-Dependent Interactions**

---

**NS composed primarily of neutrons.**

**No difference between spin-independent and spin-dependent interactions.**

## STAGE I: CAPTURE: PARTICLE PHYSICS IMPEDIMENTS

- ▶ Two impediments to dark matter interactions:
  - ▶ Pauli Blocking (low-mass dark matter)
  - ▶ Dark Matter Capture (high-mass dark matter)

Dark Matter scattering imparts a momentum:

$$\delta p \sim \gamma m_x v_{\text{esc}},$$

Typical NS neutron momentum is:

$$p_{F,n} \simeq 0.45 \text{ GeV} \left( \rho_{NS} / (4 \times 10^{38} \text{ GeV cm}^{-3}) \right)$$

This suppresses the interaction cross-section for low mass DM:

$$\sigma_{\text{sat}}^{\text{Pauli}} \simeq \pi R^2 m_n p_f / (M \gamma m_x v_{\text{esc}}) \simeq 2 \times 10^{-45} \text{ cm}^2 \left( \frac{\text{GeV}}{m_x} \right) \left( \frac{1.5 M_{\odot}}{M} \right) \left( \frac{R}{10 \text{ km}} \right)^2.$$



## STAGE I: CAPTURE: PARTICLE PHYSICS IMPEDIMENTS

---

- ▶ **Two impediments to dark matter interactions:**
    - ▶ **Pauli Blocking (low-mass dark matter)**
    - ▶ **Dark Matter Capture (high-mass dark matter)**
- 

**Dark Matter energy lost in a scatter with a GeV proton is approximately:**

$$E_{loss} = \frac{2m_p}{m_\chi} (m_\chi v_\chi^2)$$

**If this is smaller than the DM kinetic energy at infinity the dark matter will not remain bound after a single interaction:**

$$\sigma_{\text{sat}}^{\text{multi}} \simeq 2 \times 10^{-45} \text{ cm}^2 \left( \frac{m_\chi}{\text{PeV}} \right) \left( \frac{1.5 M_\odot}{M} \right) \left( \frac{R}{10 \text{ km}} \right)^2.$$

# STAGE I: CAPTURE: PARTICLE PHYSICS IMPEDIMENTS

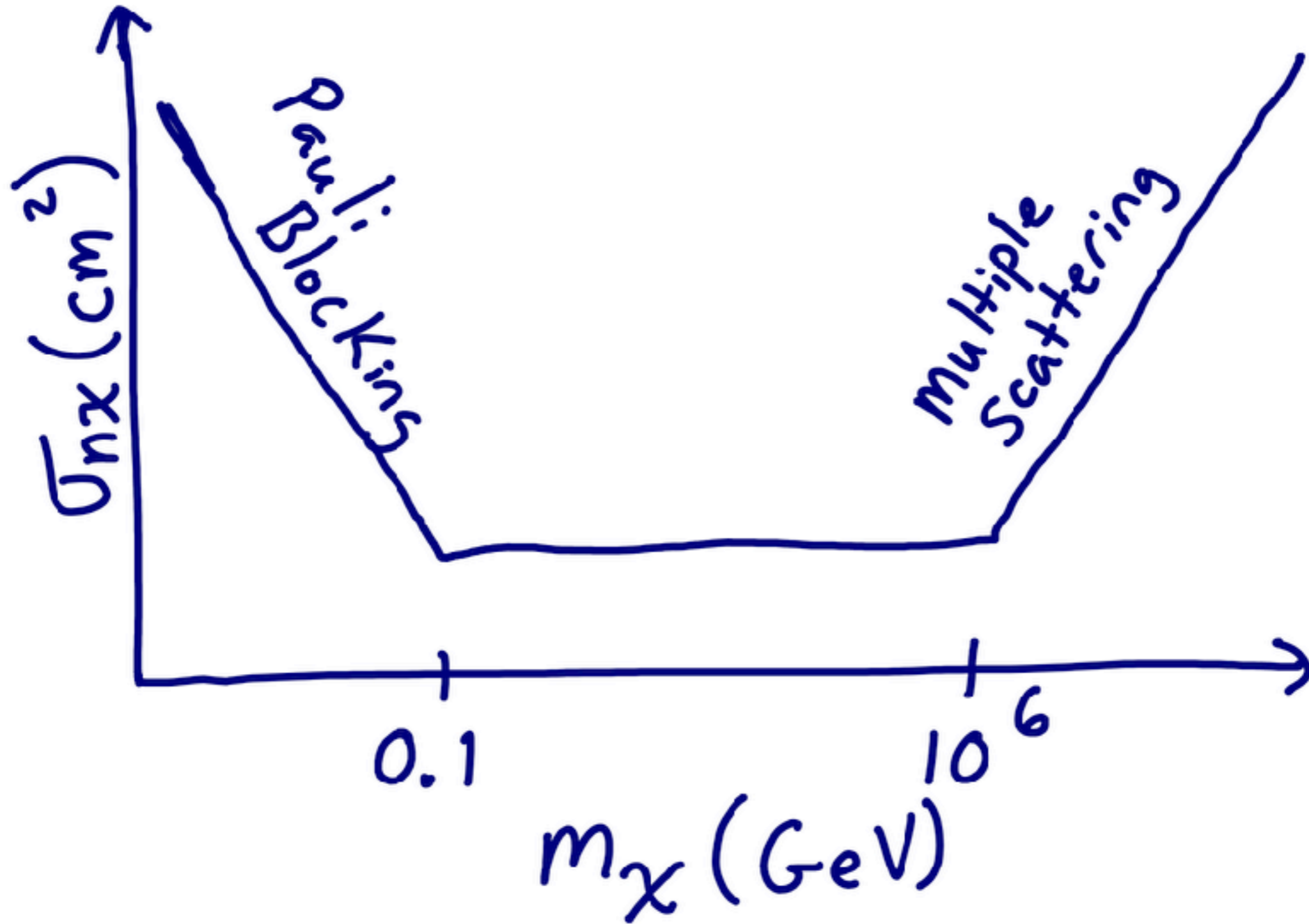



- ▶ **Dark Matter thermalization is always suppressed by Pauli blocking.**
- ▶ **Analytical and numerical models have very different predictions.**

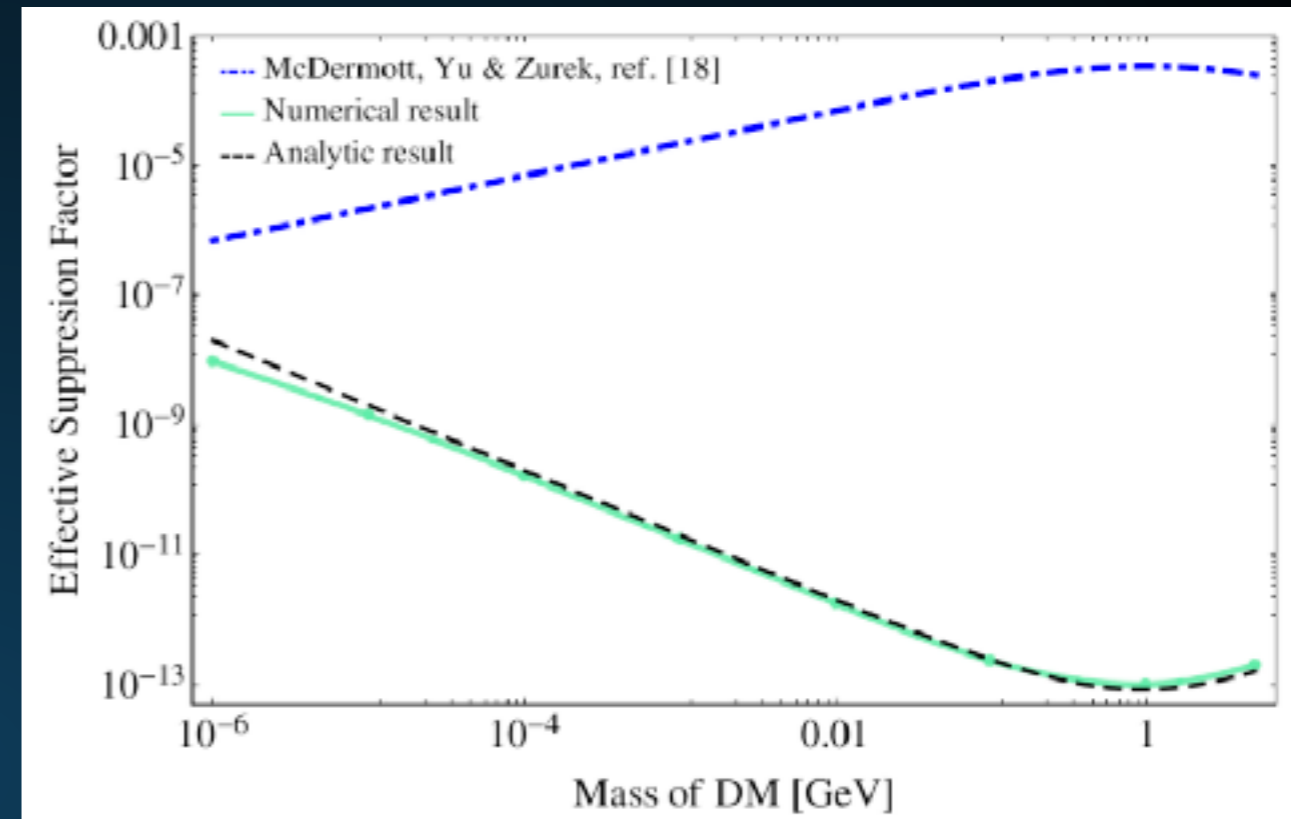

- ▶ **However, if DM is trapped within the NS, interactions are still inevitable, and dark matter thermalizes on a significantly smaller timescale than DM capture:**

$$t_{th} \simeq 3.7 \text{ kyr} \frac{\frac{m_X}{m_B}}{\left(1 + \frac{m_X}{m_B}\right)^2} \left( \frac{2 \times 10^{-45} \text{ cm}^2}{\sigma_{nX}} \right) \left( \frac{10^5 \text{ K}}{T_{NS}} \right)^2$$

## STAGE III: ANNIHILATION OR COLLAPSE

---

- ▶ Two paths are now possible:
  - ▶ **If dark matter can annihilate**, the large densities make annihilation inevitable.
  - ▶ **If dark matter cannot annihilate**, dark matter builds mass until it exceeds its own degeneracy pressure. For Fermionic dark matter this is:

$$M_{crit}^{ferm} \simeq M_{pl}^3 / m_X^2$$

- ▶ It then collapses on a timescale:

$$\begin{aligned} \tau_{co} &\simeq \frac{1}{n\sigma_{nx}v_x} \left( \frac{p_F}{\Delta p} \right) \left( \frac{m_x}{2m_n} \right) \\ &\simeq 4 \times 10^5 \text{ yrs} \left( \frac{10^{-45} \text{ cm}^2}{\sigma_{nx}} \right) \left( \frac{r_x}{r_0} \right), \end{aligned}$$



## STAGE III: PARTICLE PHYSICS MOTIVATIONS FOR COLLAPSE

---

- ▶ **Asymmetric Dark Matter is well-motivated**
  - ▶ e.g. Baryon/Lepton Asymmetry through dark baryogenesis
- ▶ **Some models do not work, e.g. GeV Fermions require  $\sim 1 M_{\odot}$  of dark matter to be accreted**

$$M_{crit}^{ferm} \simeq M_{pl}^3 / m_{\chi}^2$$

- ▶ **Many models do work:**
  - ▶ **PeV Fermionic DM ( $\sim 10^{-10} M_{\odot}$ )**
  - ▶ **Bosonic DM (MeV - PeV) with small quartic**
  - ▶ **MeV-PeV DM with attractive potential (e.g. Scalar Higgs Portal)**

# ASTROPHYSICAL OBSERVATIONS

---

- ▶ **Key Goals:**

- ▶ **Observe an astrophysical signature from dark matter accumulation in neutron stars**
- ▶ **Differentiate this signal from astrophysics.**



## POSSIBLE SIGNATURES OF DARK MATTER INTERACTIONS

---

- ▶ **Neutron star heating - Requires only dark matter accumulation (Stage I)**
  
- ▶ **Neutron star collapse (Requires Stage I, II, and III)**

## STAGE I: CAPTURE: ASTROPHYSICAL ENHANCEMENTS

### ▶ Two enhancements:

#### ▶ NS gravitational potential well

Potential moves dark matter particles into collisional orbit.

Interaction rate scales as  $v_x^{-1}$ .

$$b_{\max} = \left( \frac{2GM R}{v_x^2} \right)^{1/2} \left( 1 - \frac{2GM}{R} \right)^{-1/2}$$

200 km/s  $\rightarrow$  1 Earth Radius

$$\dot{m} = \pi b_{\max}^2 v_x \rho_x,$$

**Collision velocity is high!**

$$v_{esc} = \sqrt{\frac{2GM}{r}} \sim 0.7c$$

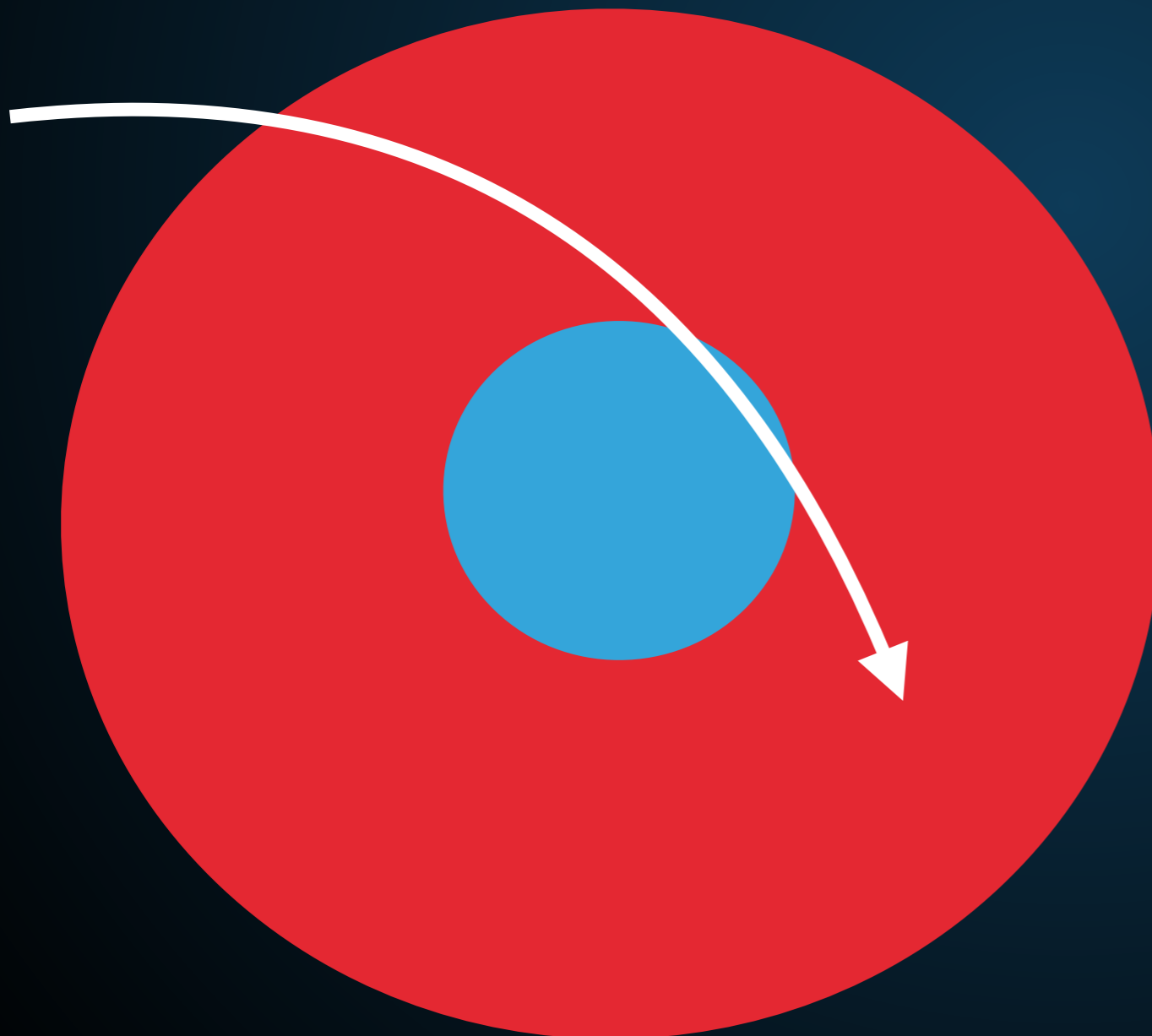



- ▶ A dark matter particle impacts a neutron star surface with significant kinetic energy:

$$\dot{m} = \pi b_{\text{max}}^2 v_x \rho_x$$

$$E_s \simeq m_x (\gamma - 1)$$

- ▶ This sets a minimum energy input to the neutron star:

$$\dot{E}_k = \frac{E_s \dot{m}}{m_x} f \simeq 1.4 \times 10^{25} \text{ GeV s}^{-1} \left( \frac{f}{1} \right)$$

de Lavallez & Fairbairn (1004.0629)

- ▶ The dark matter particle does not need to annihilate, but if it does, more energy is injected ( $E_s = \gamma m_x$ ).

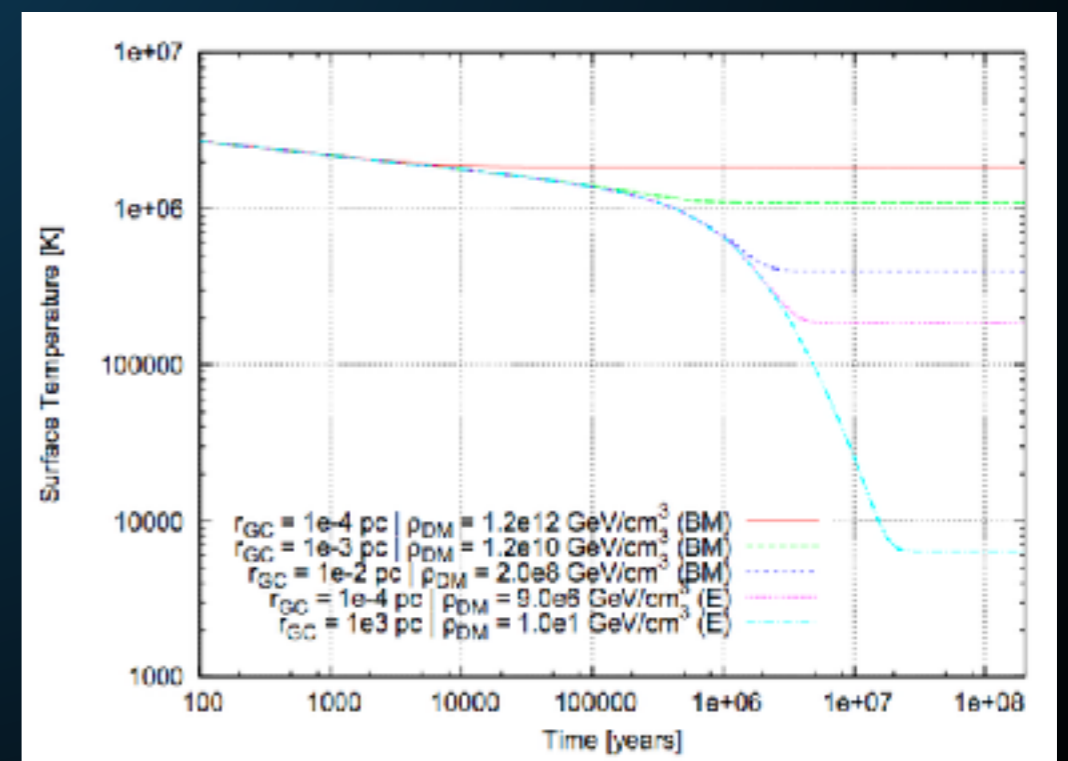

Energy In = Energy Out

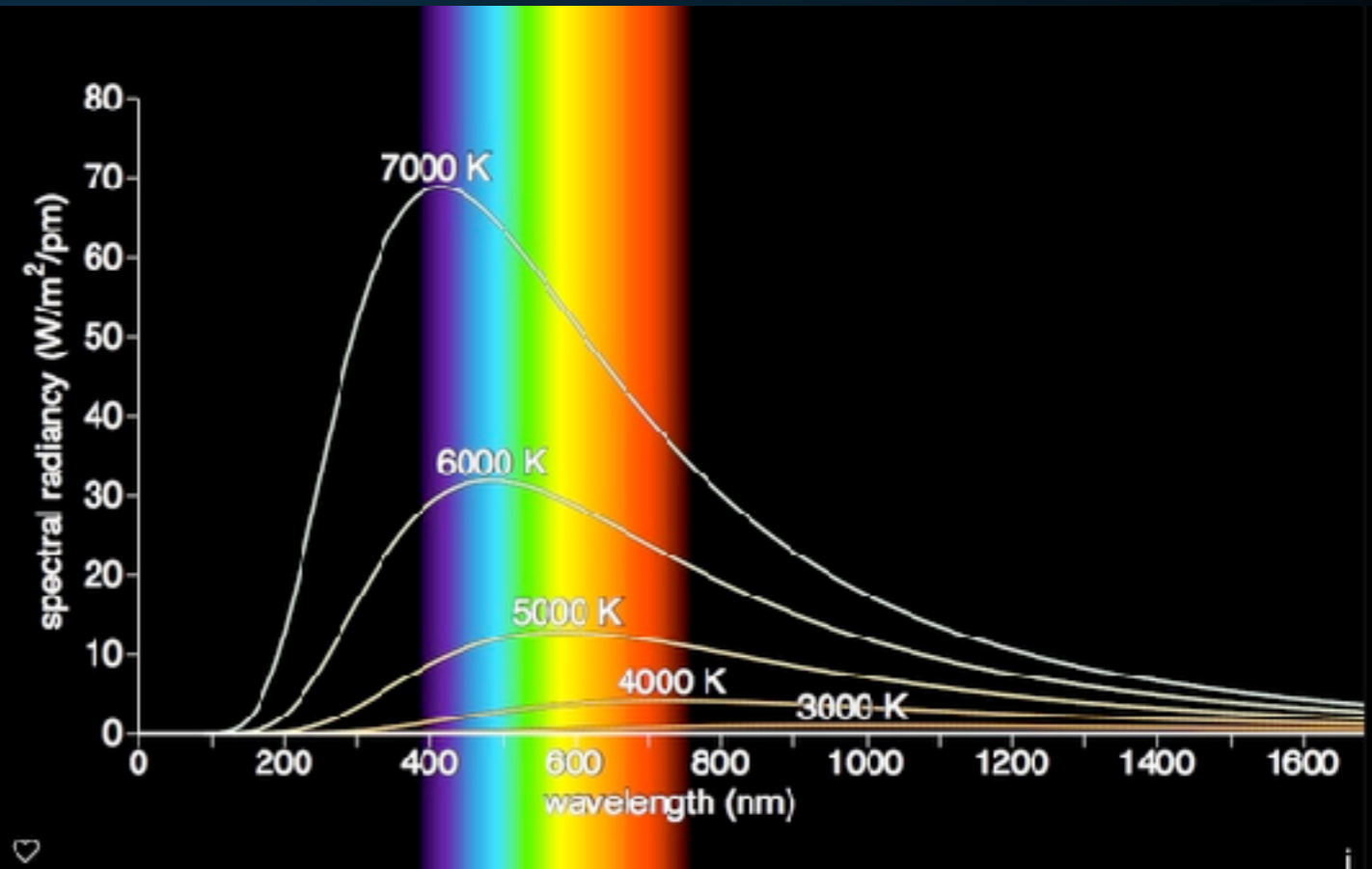
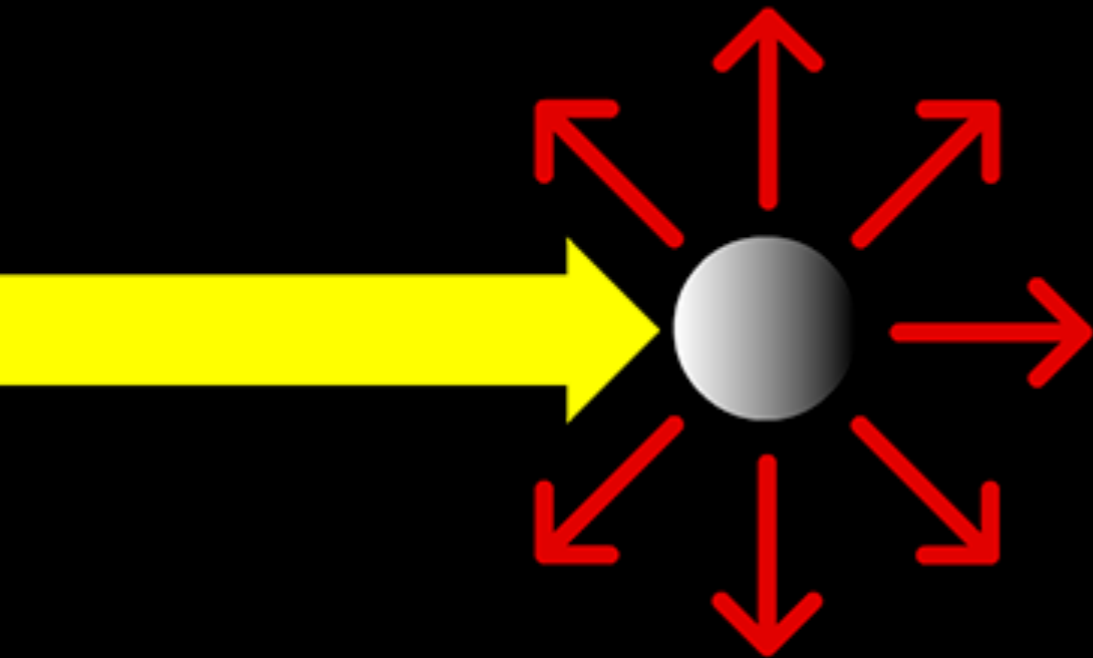



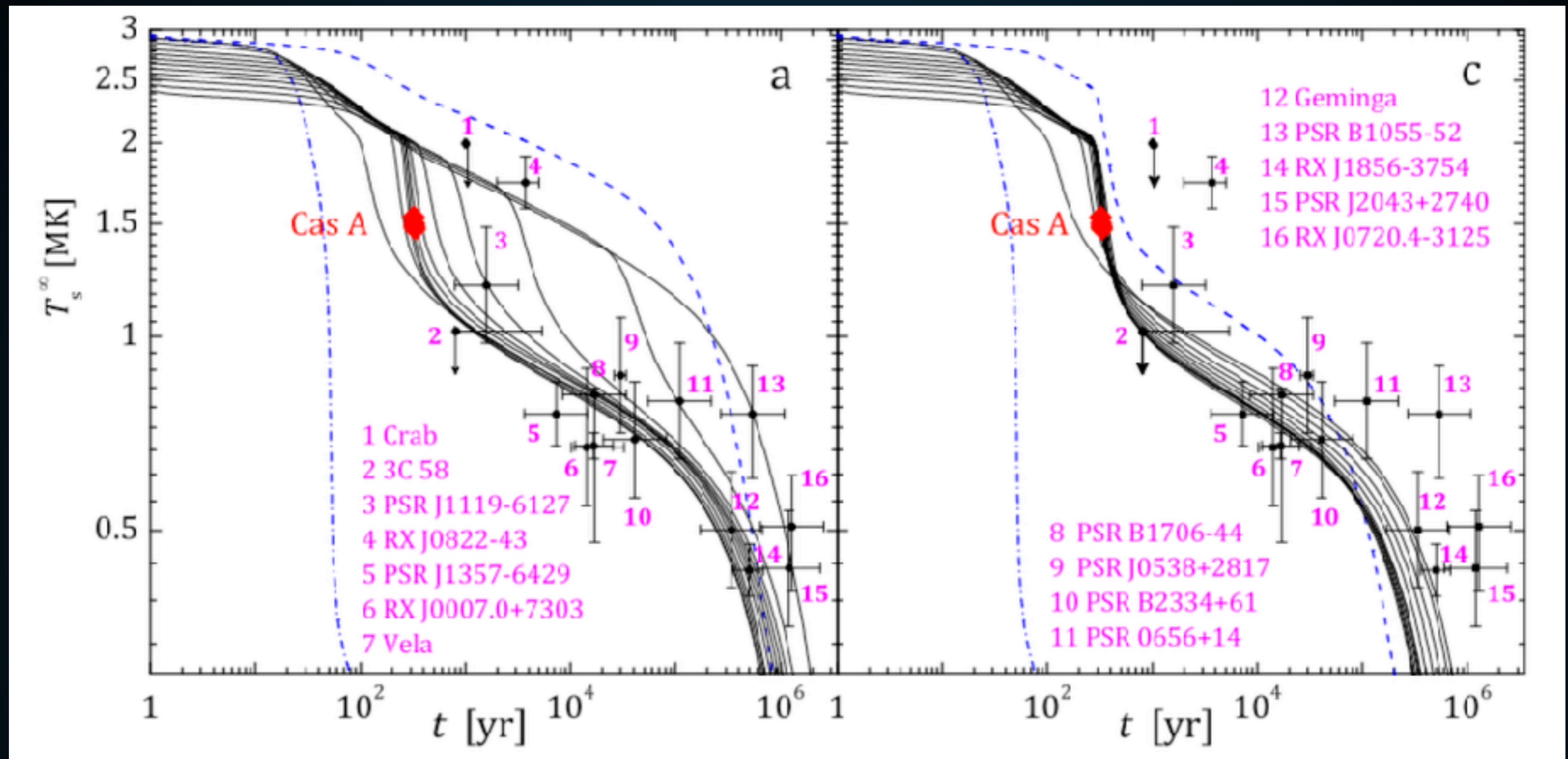

- ▶ In addition to pulsations, a handful of pulsars have been detected via blackbody radiation.
- ▶ Primarily at temperatures  $\sim 10^6$  K.

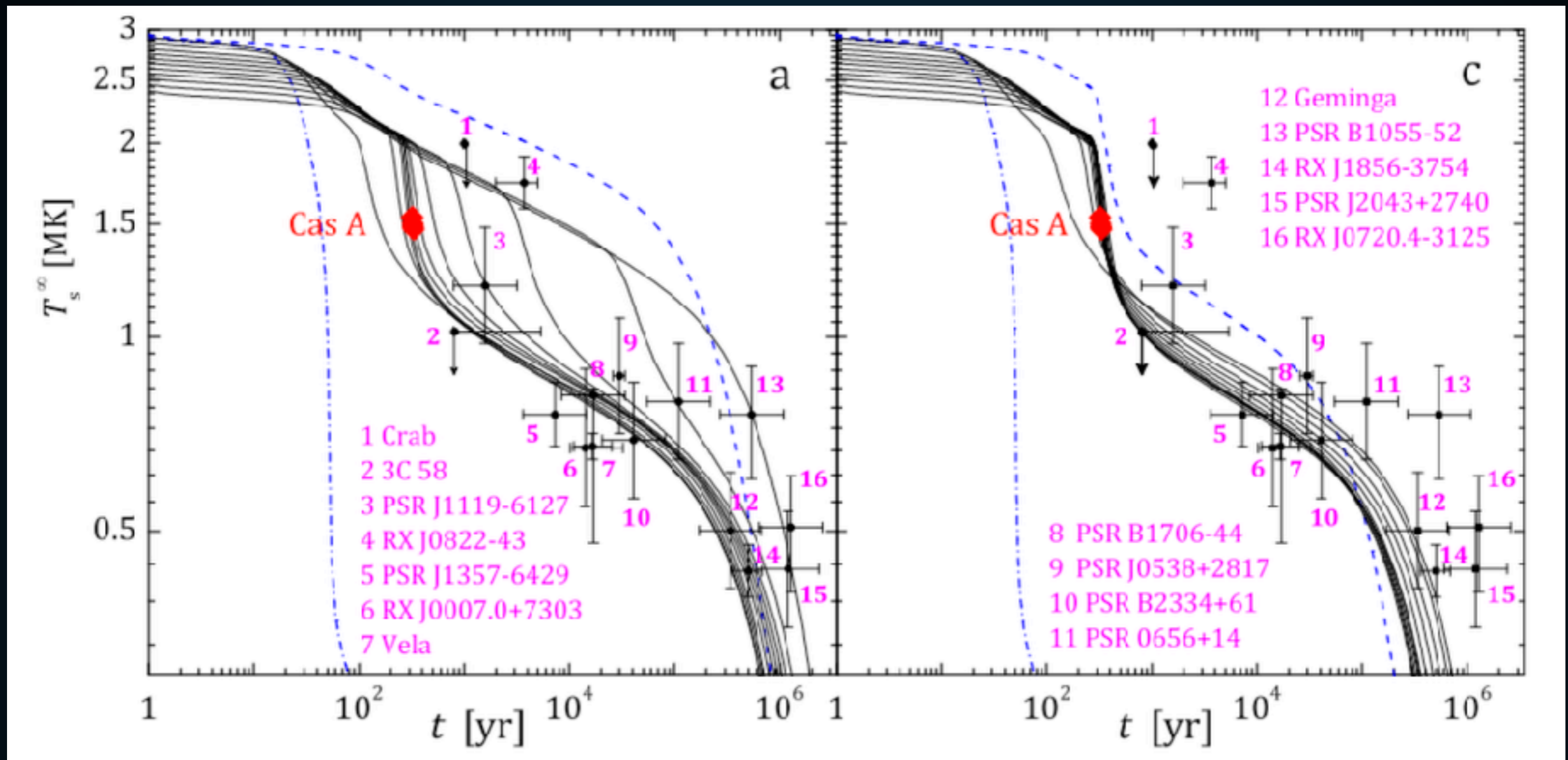

- ▶ Older neutron stars are expected to cool effectively.
- ▶ 20 Myr neutron stars are believed to have temperatures  $< 1000$  K.

- ▶ Dark matter then thermalizes with the NS.
- ▶ Energy transferred into nucleon kinetic energy.
- ▶ Neutron star emits as a blackbody with luminosity:

$$L_{\infty}^{\text{dark}} = \dot{E}_k \left( 1 - \frac{2GM}{R} \right) = 4\pi\sigma_B R^2 T_s^4 \left( 1 - \frac{2GM}{R} \right)$$

- ▶ This corresponds to a temperature  $\sim 1750$  K for dark matter saturating the direct detection cross-section.
- ▶ Exceeds the sensitivity of standard direct detection.

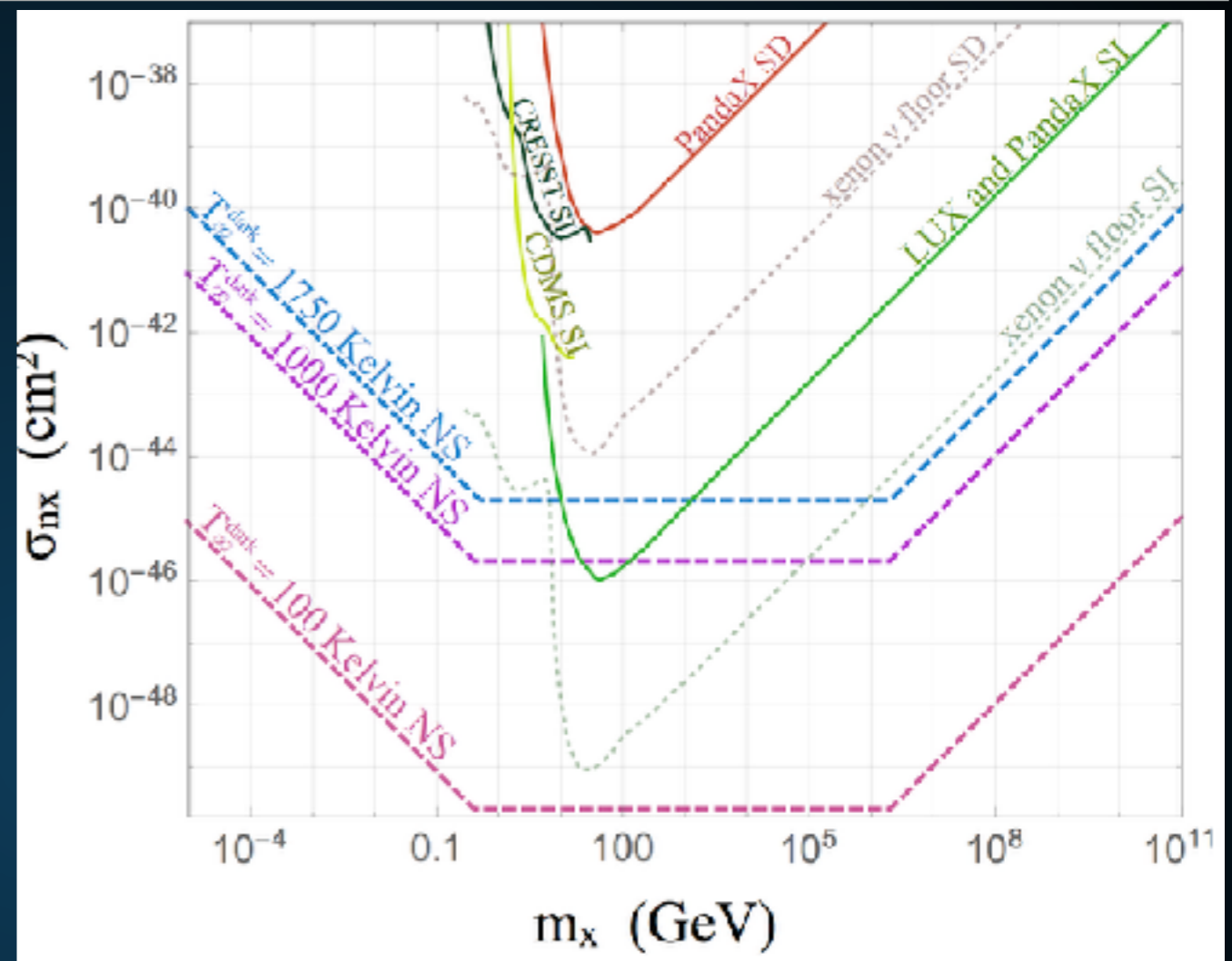



- ▶ Seeing this signal requires extremely sensitive infrared observations.
- ▶ New Telescopes coming online:

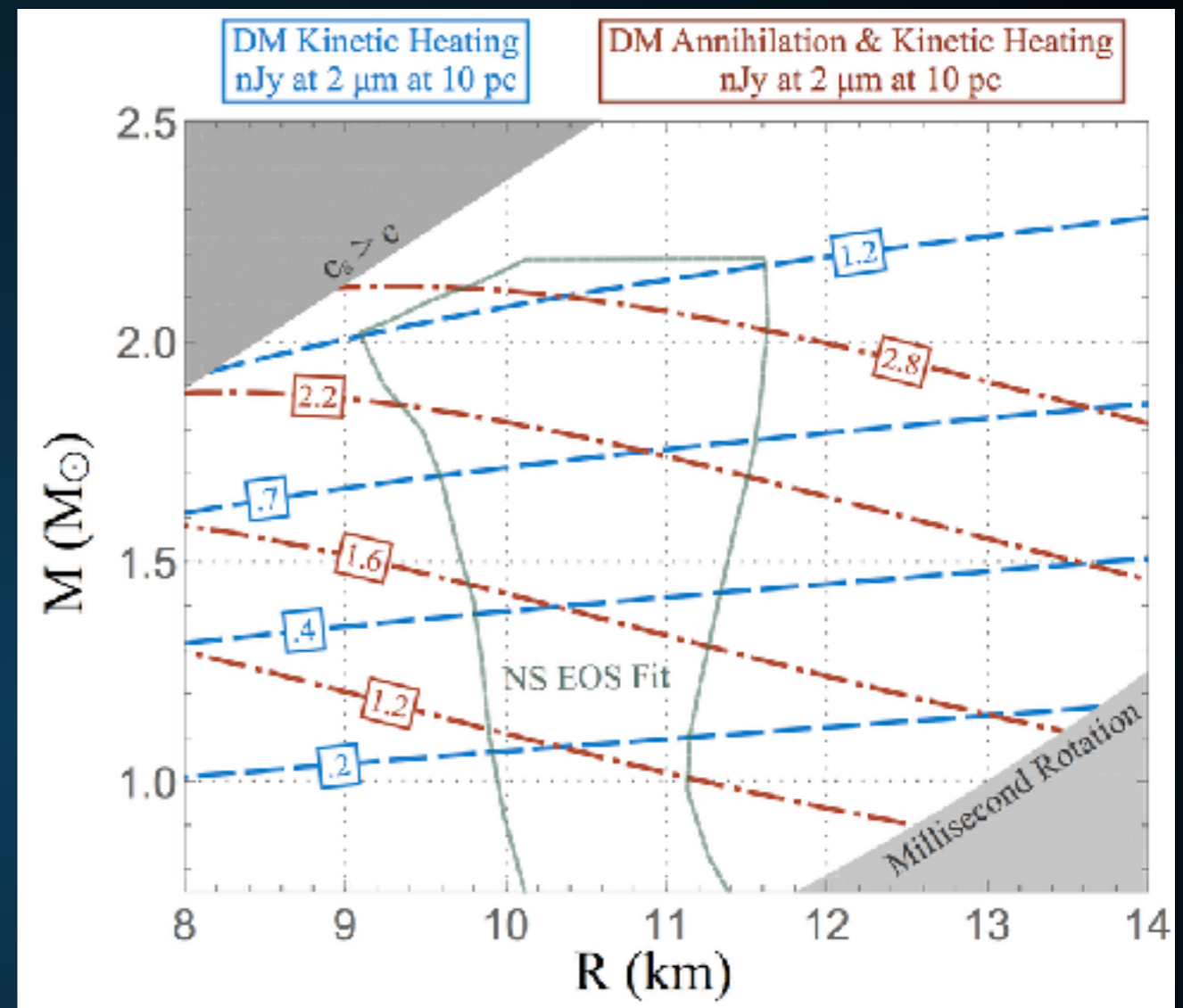

- ▶ JWST - sensitivity is  $\sim 10$  nJy at  $10^4$  s.
- ▶ TMT - 0.5 nJy in  $\sim 10^5$  s, backgrounds uncertain

- ▶ **Neutron star needs to be a pulsar, so it can be located in radio observations.**
  - ▶ **Closest pulsar ~90 pc, but models indicate a pulsar with distance ~10-20 pc should exist.**
- ▶ **Alternative heating mechanisms:**
  - ▶ **Baryonic Heating on interstellar medium?**
  - ▶ **Heating powered by magnetic turbulence?**

# POSSIBLE SIGNATURES OF DARK MATTER INTERACTIONS

---

- ▶ **Neutron star heating - Requires only dark matter accumulation (Stage I)**
- ▶ **Neutron star collapse (Requires Stage I, II, and III)**
  - ▶ **Missing neutron stars**
  - ▶ **Electromagnetic signatures**
    - ▶ **Fast Radio Bursts**
    - ▶ **Kilonovae**
    - ▶ **r-process enrichment**
  - ▶ **Gravitational wave signatures**



# A CONSTRAINT!

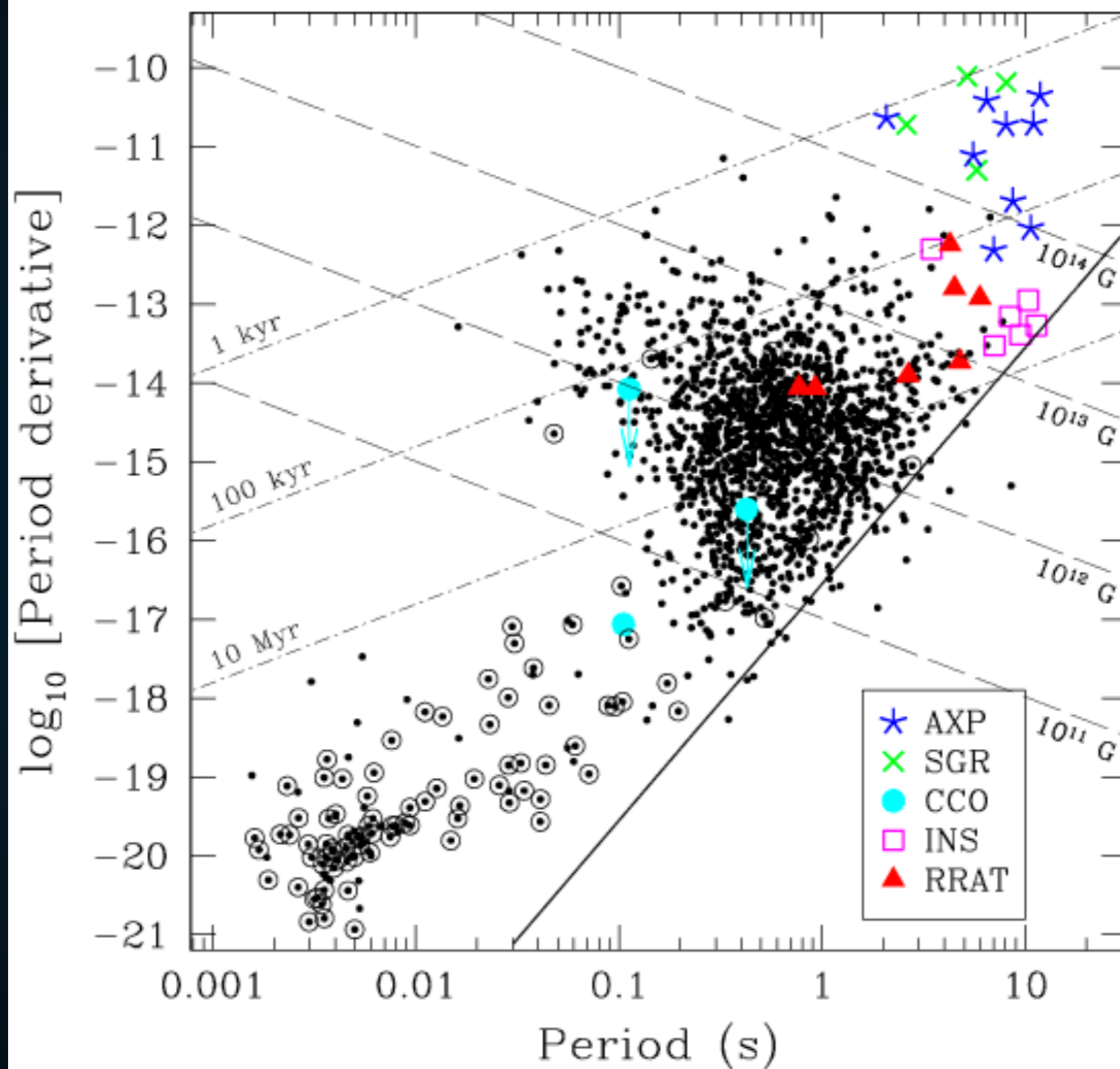

# PROBLEM: WE SEE OLD NEUTRON STARS

McDermott et al. (1103.5472)

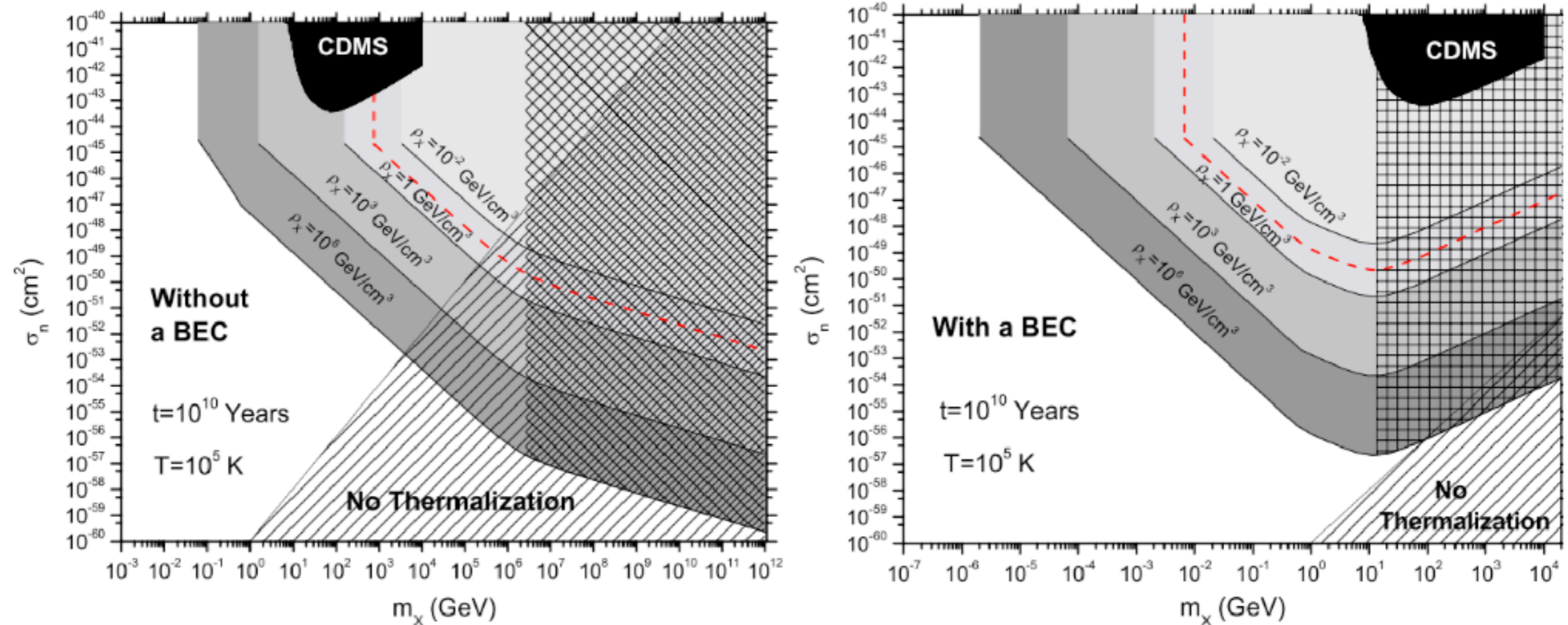

- ▶ We observe ~5 Gyr old neutron stars us.
- ▶ Thus dark matter must not collapse neutron stars too effectively.
- ▶ Sets strong constraints on dark matter that collapses neutron stars - e.g. here in the case of scalar dark matter.



# A SIGNAL !?

---





# Massive Star Formation in the Galactic Center

By Don F. Figer

Rochester Institute of Technology, Rochester, NY, USA

The Galactic center is a hotbed of star formation activity, containing the most massive star formation site and three of the most massive young star clusters in the Galaxy. Given such a rich environment, it contains more stars with initial masses above  $100 M_{\odot}$  than anywhere else in the Galaxy. This review concerns the young stellar population in the Galactic center, as it relates to massive star formation in the region. The sample includes stars in the three massive stellar clusters, the population of younger stars in the present sites of star formation, the stars surrounding the central black hole, and the bulk of the stars in the field population. The fossil record in the Galactic center suggests that the recently formed massive stars there are present-day examples of similar populations that must have been formed through star formation episodes stretching back to the time period when the Galaxy was forming.

---

## 1. Introduction

The Galactic center (GC) is an exceptional region for testing massive star formation and evolution models. It contains 10% of the present star formation activity in the Galaxy, yet fills only a tiny fraction of a percent of the volume in the Galactic disk†. The initial



# THE MISSING PULSAR PROBLEM



- ▶ The Galactic center should host  $\sim 10\%$  of the young pulsars surrounding the Galactic center.
- ▶ We haven't seen them?



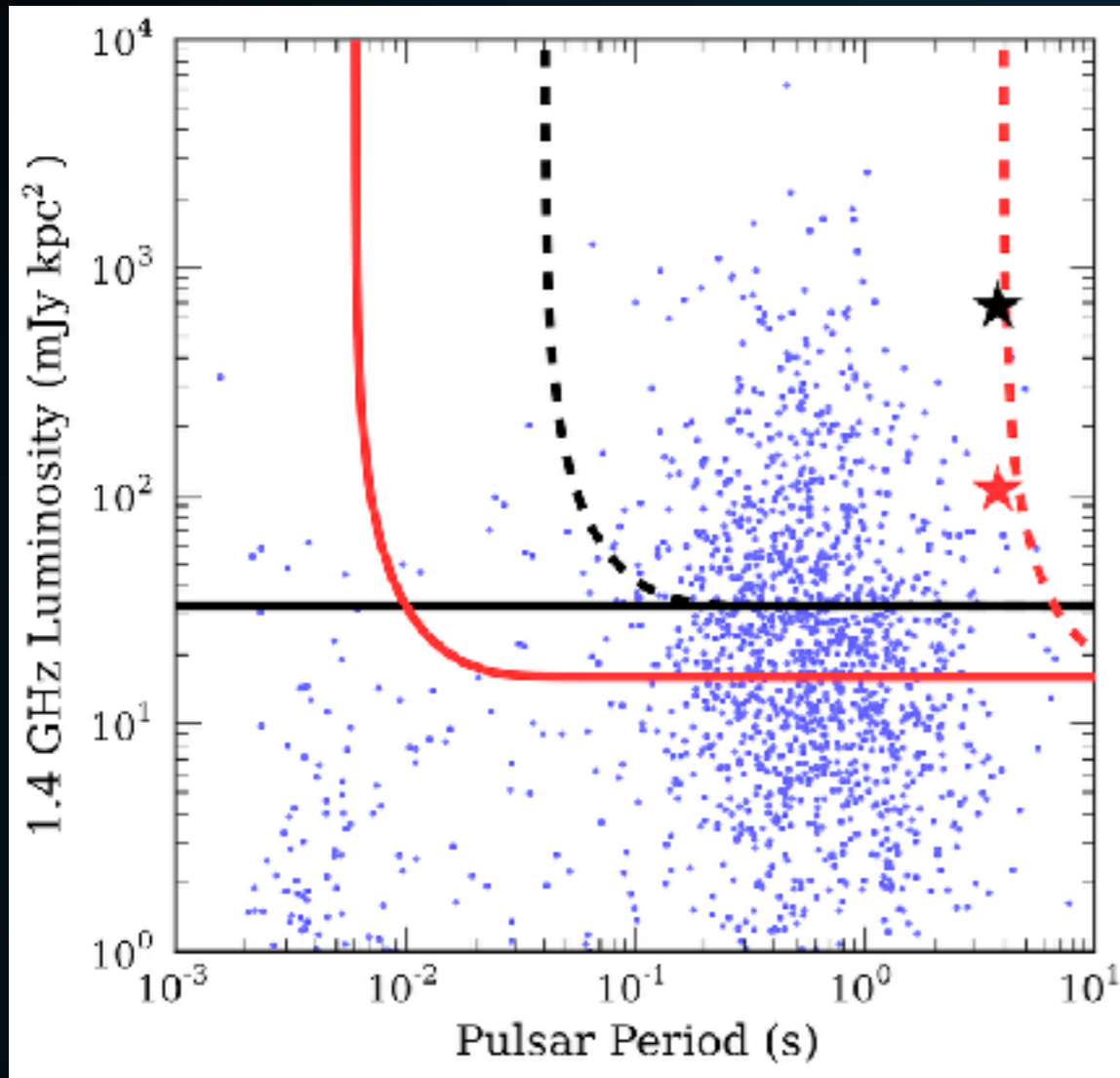

- ▶ Large pulse dispersion was reasonable culprit

$$\Delta\tau \sim 1 \text{ s} \left( \frac{\text{Ghz}}{\nu} \right)^4$$

- ▶ Magnetar found in X-Ray observations in 2013.

- ▶ No pulse dispersion in X-Rays

- ▶ Magnetar subsequently found in radio

- ▶ Pulse dispersion is small!

- ▶ Why aren't any other pulsars observed !?



- ▶ **High Dark Matter density near the GC.**

$$\rho(r) = \frac{\rho_0}{\frac{r}{R_s} \left(1 + \frac{r}{R_s}\right)^2}$$

- ▶ **GC NS collapse in  $\sim 10^5$  yr while nearby NS remain.**

- ▶ **Constrains cross-section to within a few orders of magnitude.**

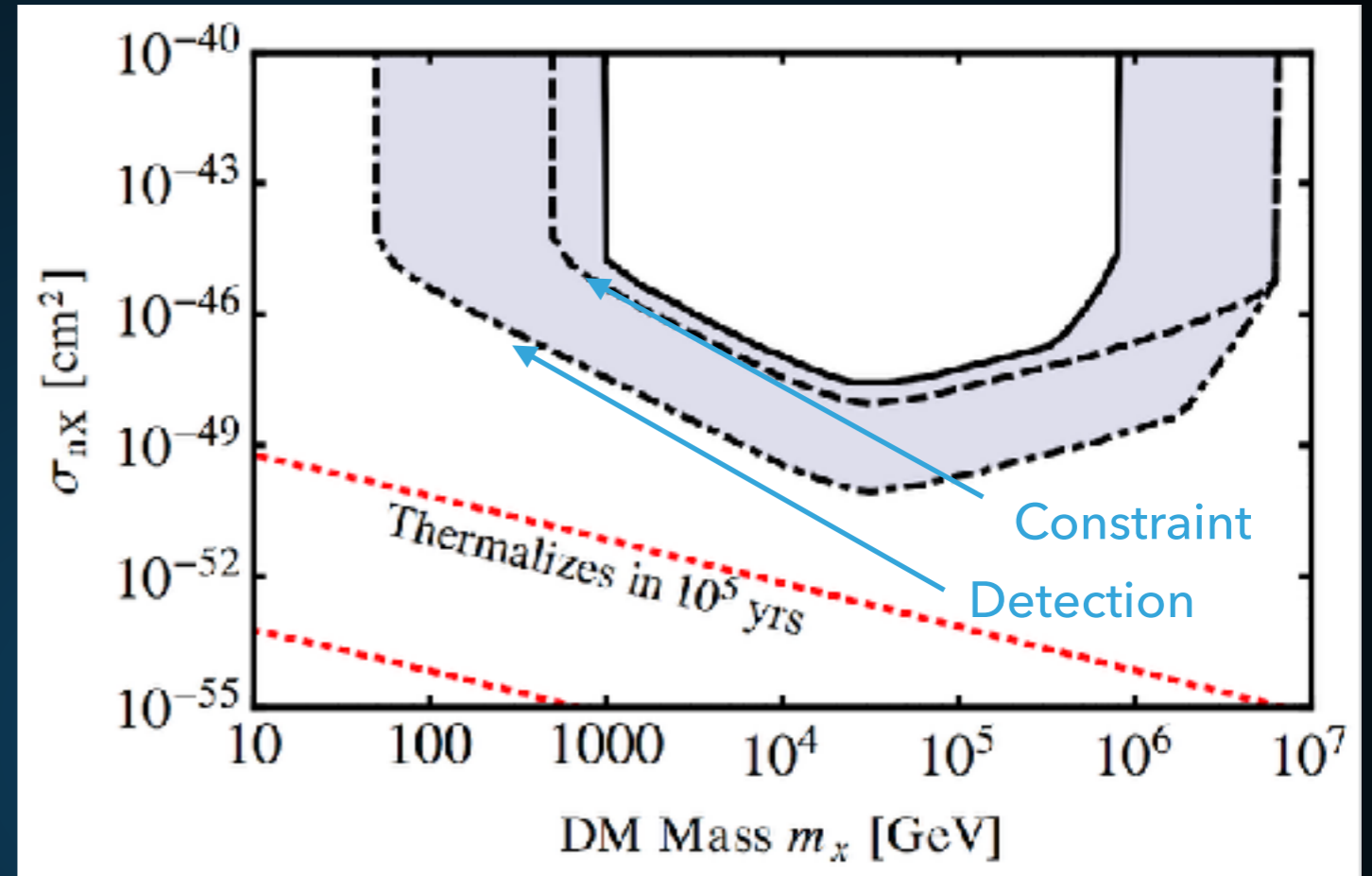

Bosonic DM  
 $\lambda|\phi|^4 = 10^{-15}$ .

- ▶ **Potential Observation: A correlation between maximum NS age and GC radius.**
- ▶ **Can be confirmed or ruled out with one old pulsar observation near the GC.**
- ▶ **Upcoming radio instruments (e.g. MeerKat, SKA) will definitively test the missing pulsar problem.**

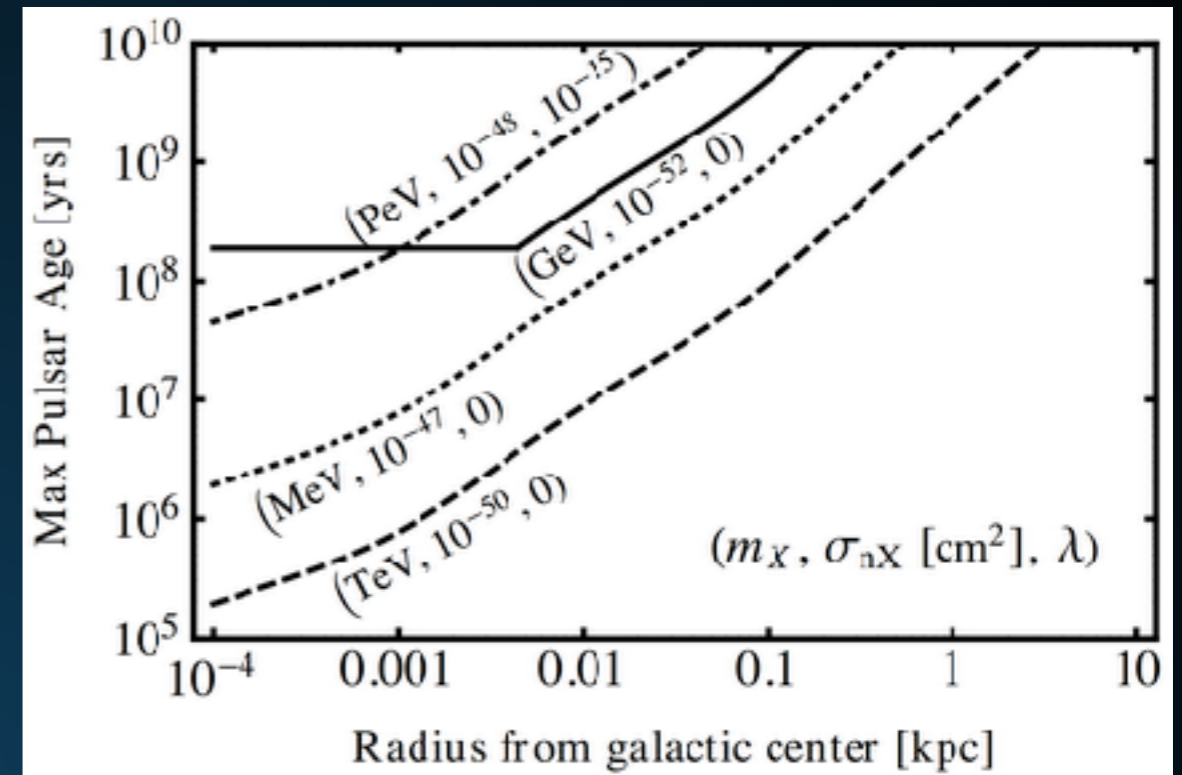

Eatough et al. (1501.00281)

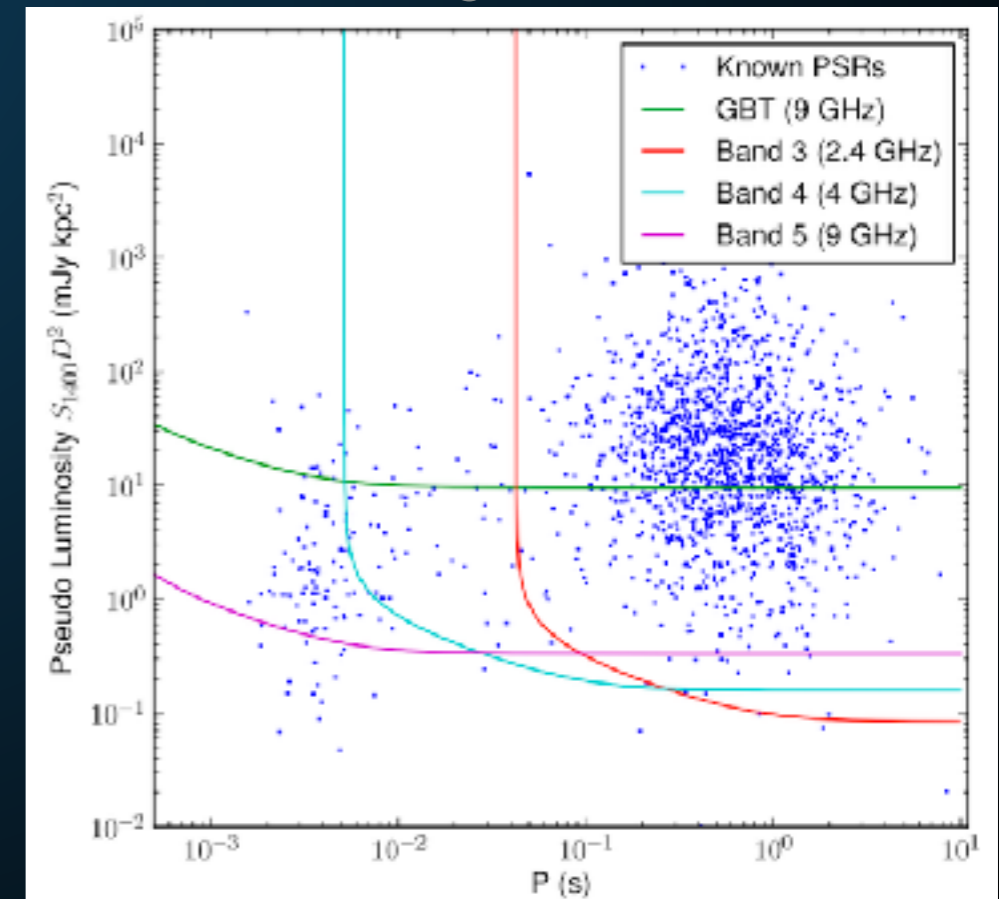

## POSSIBLE SIGNATURES OF DARK MATTER INTERACTIONS

---

- ▶ **Hard to discover dark matter with a dog that didn't bark....**



# POSSIBLE SIGNATURES OF DARK MATTER INTERACTIONS

---

- ▶ **Hard to discover dark matter with a dog that didn't bark....**
- ▶ **Can we find a positive signature of dark matter induced neutron star collapse?**
  - ▶ **Gravitational wave signatures**
  - ▶ **Electromagnetic signatures**
    - ▶ **Fast Radio Bursts**
    - ▶ **Kilonovae**
    - ▶ **r-process enrichment**



## Multi-messenger Observations of a Binary Neutron Star Merger

LIGO Scientific Collaboration and Virgo Collaboration, Fermi GBM, INTEGRAL, IceCube Collaboration, AstroSat Cadmium Zinc Telluride Imager Team, IPN Collaboration, The Insight-Hxmt Collaboration, ANTARES Collaboration, The Swift Collaboration, AGILE Team, The 1M2H Team, The Dark Energy Camera GW-EM Collaboration and the DES Collaboration, The DLT40 Collaboration, GRAWTA: GRAVitational Wave Inaf TeAm, The Fermi Large Area Telescope Collaboration, ATCA: Australia Telescope Compact Array, ASKAP: Australian SKA Pathfinder, Las Cumbres Observatory Group, OzGrav, DWF<sup>2</sup> (Deeper, Wider, Faster Program), AST3, and CAASTRO Collaborations, The VINROUGE Collaboration, MASTER Collaboration, J-GEM, GROWTH, JAGWAR, Caltech-NRAO, TTU-NRAO, and NuSTAR Collaborations, Pan-STARRS, The MAXI Team, TZAC Consortium, KU Collaboration, Nordic Optical Telescope, ePESSTO, GROND, Texas Tech University, SALT Group, TOROS: Transient Robotic Observatory of the South Collaboration, The BOOTES Collaboration, MWA: Murchison Widefield Array, The CALET Collaboration, IKI-GW Follow-up Collaboration, H.E.S.S. Collaboration, LOFAR Collaboration, LWA: Long Wavelength Array, HAWC Collaboration, The Pierre Auger Collaboration, ALMA Collaboration, Euro VLBI Team, Pi of the Sky Collaboration, The Chandra Team at McGill University, DFN: Desert Fireball Network, ATLAS, High Time Resolution Universe Survey, RIMAS and RATIR, and SKA South Africa/MeerKAT  
(See the end matter for the full list of authors.)

Received 2017 October 3; revised 2017 October 6; accepted 2017 October 6; published 2017 October 16

### Abstract

On 2017 August 17 a binary neutron star coalescence candidate (later designated GW170817) with merger time 12:41:04 UTC was observed through gravitational waves by the Advanced LIGO and Advanced Virgo detectors. The *Fermi* Gamma-ray Burst Monitor independently detected a gamma-ray burst (GRB 170817A) with a time delay of  $\sim 1.7$  s with respect to the merger time. From the gravitational-wave signal, the source was initially localized to a sky region of  $31 \text{ deg}^2$  at a luminosity distance of  $40^{+8}_{-8}$  Mpc and with component masses consistent with neutron stars. The component masses were later measured to be in the range  $0.86$  to  $2.26 M_{\odot}$ . An extensive observing campaign was launched across the electromagnetic spectrum leading to the discovery of a bright optical transient (SSS17a, now with the IAU identification of AT 2017gfo) in NGC 4993 (at  $\sim 40$  Mpc) less than 11 hours after the merger by the One-Meter, Two Hemisphere (1M2H) team using the 1 m Swope Telescope. The optical transient was independently detected by multiple teams within an hour. Subsequent observations targeted the object and its environment. Early ultraviolet observations revealed a blue transient that faded within 48 hours. Optical and infrared observations showed a redward evolution over  $\sim 10$  days. Following early non-detections, X-ray and radio emission were discovered at the transient's position  $\sim 9$  and  $\sim 16$  days, respectively, after the merger. Both the X-ray and radio emission likely arise from a physical process that is distinct from the one that generates the UV/optical/near-infrared emission. No ultra-high-energy gamma-rays and no neutrino candidates consistent with the source were found in follow-up searches. These observations support the hypothesis that GW170817 was produced by the merger of two neutron stars in NGC 4993 followed by a short gamma-ray burst (GRB 170817A) and a kilonova/macronova powered by the radioactive decay of *r*-process nuclei synthesized in the ejecta.



# NEUTRON STAR COLLAPSE PRODUCES NEUTRON STAR MERGER SIGNALS

---

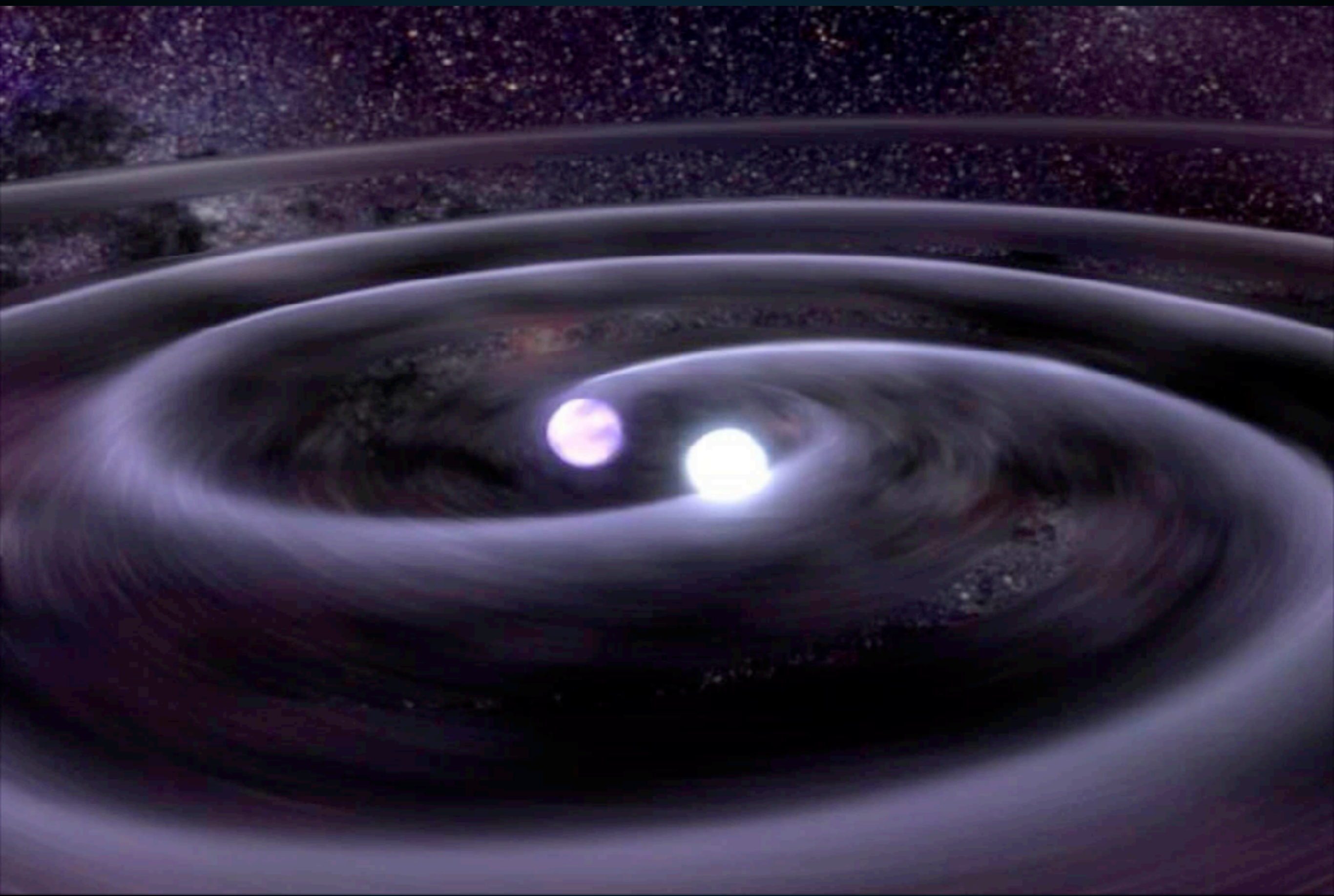



# A NEW SOURCE OF GRAVITATIONAL AND ELECTROMAGNETIC SIGNALS

- ▶ Disassociation of electromagnetic and gravitational wave signatures

## No DM Induced Collapse

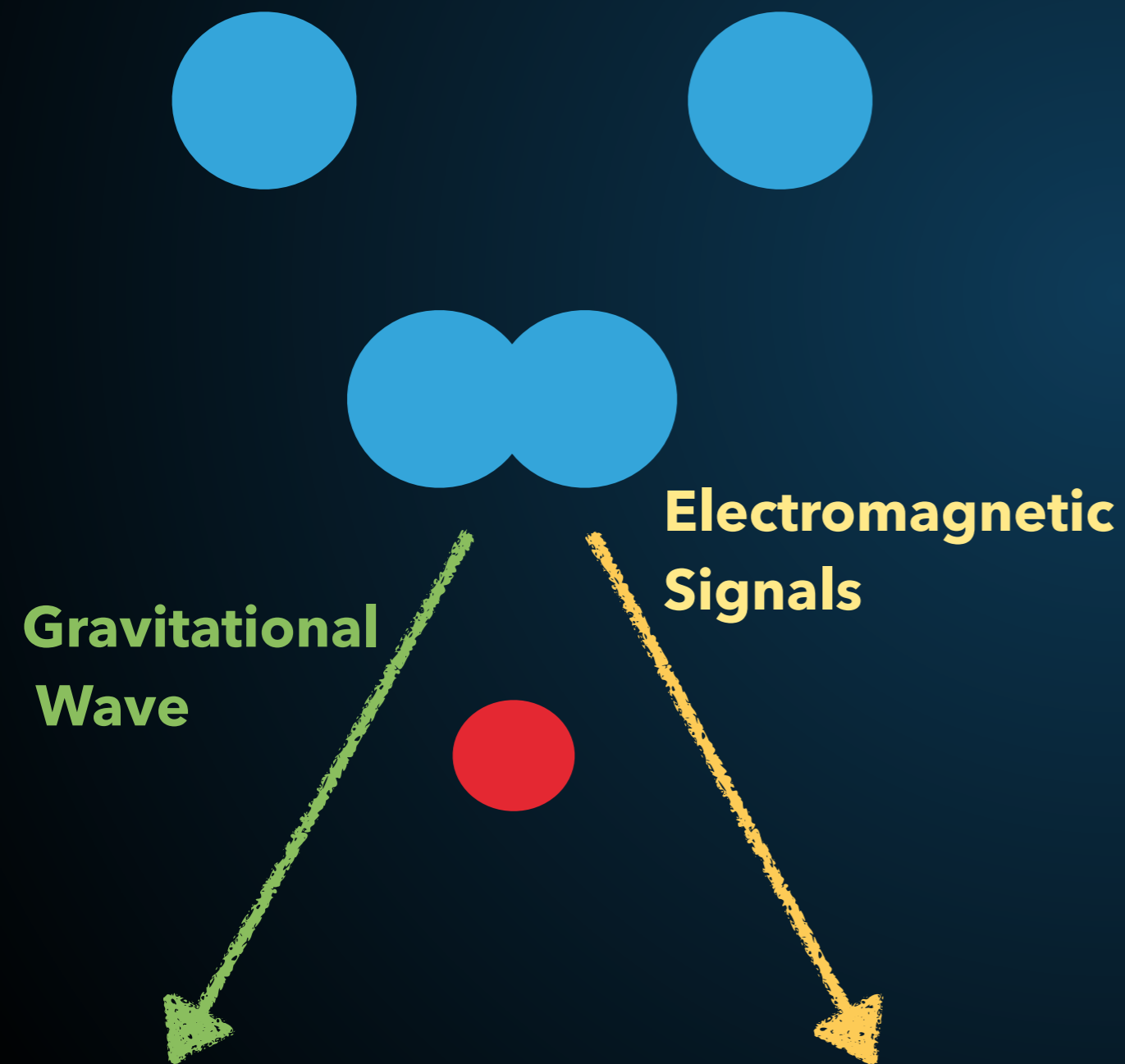

## **DM Induced Collapse**

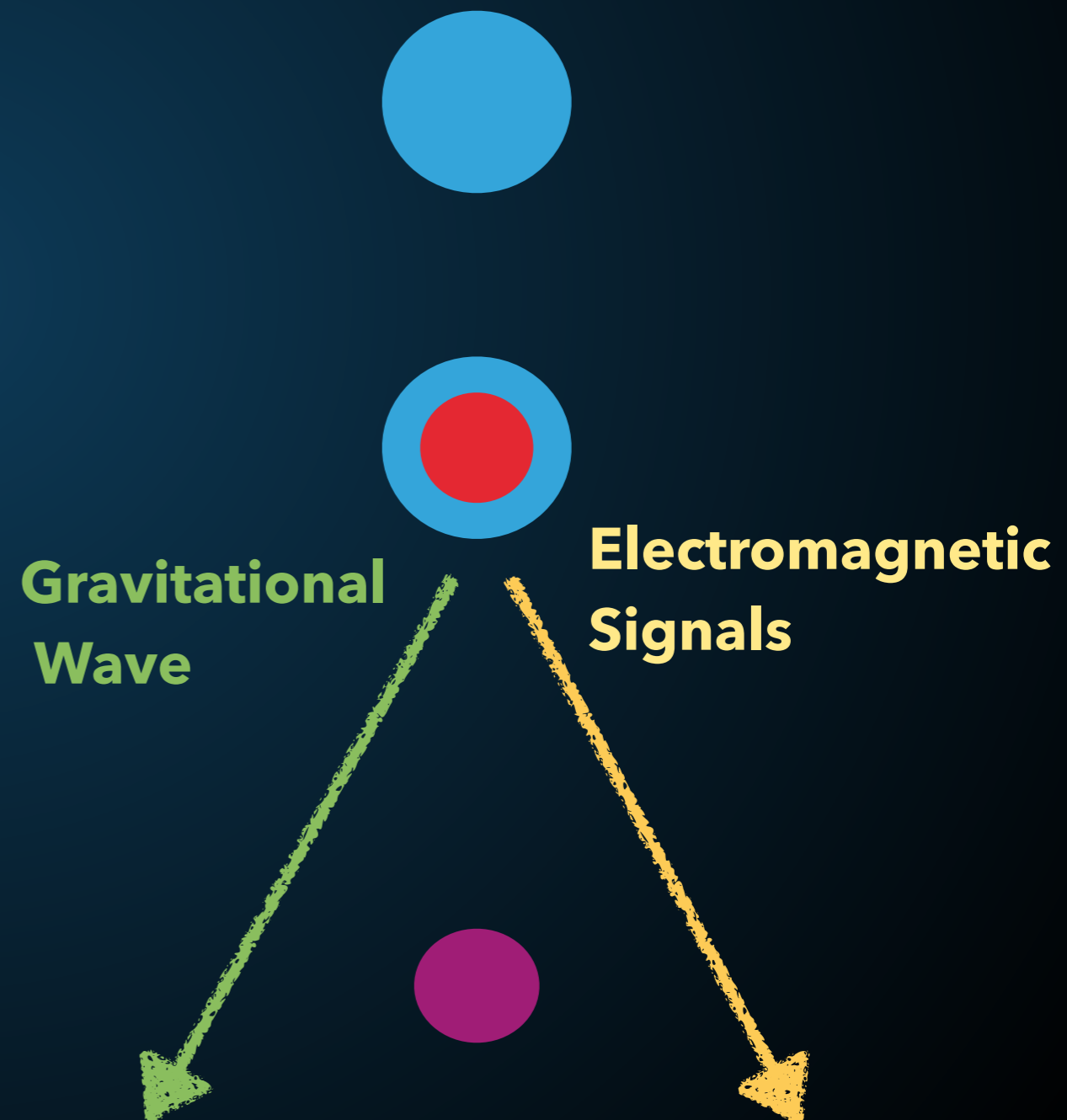

# DISSOCIATION OF EM AND GRAVITATIONAL SIGNATURES

- ▶ Disassociation of electromagnetic and gravitational wave signatures

## No DM Induced Collapse



Electromagnetic  
Signals

Gravitational  
Wave



Gravitational  
Wave

## Binary DM Induced Collapse

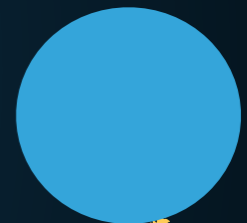



# DISSOCIATION OF EM AND GRAVITATIONAL SIGNATURES

- ▶ Disassociation of electromagnetic and gravitational wave signatures

## No DM Induced Collapse

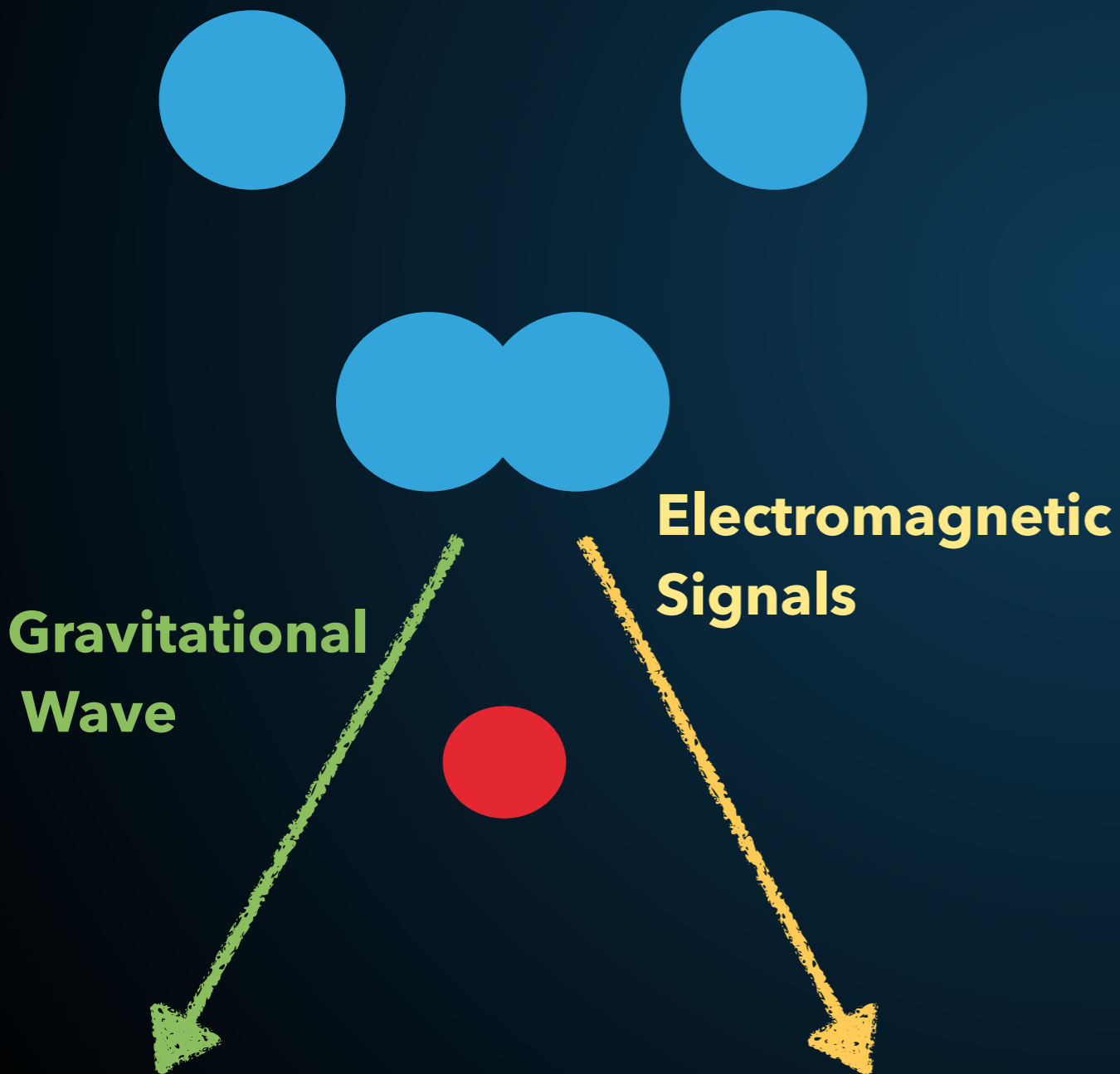

## DM Induced Collapse

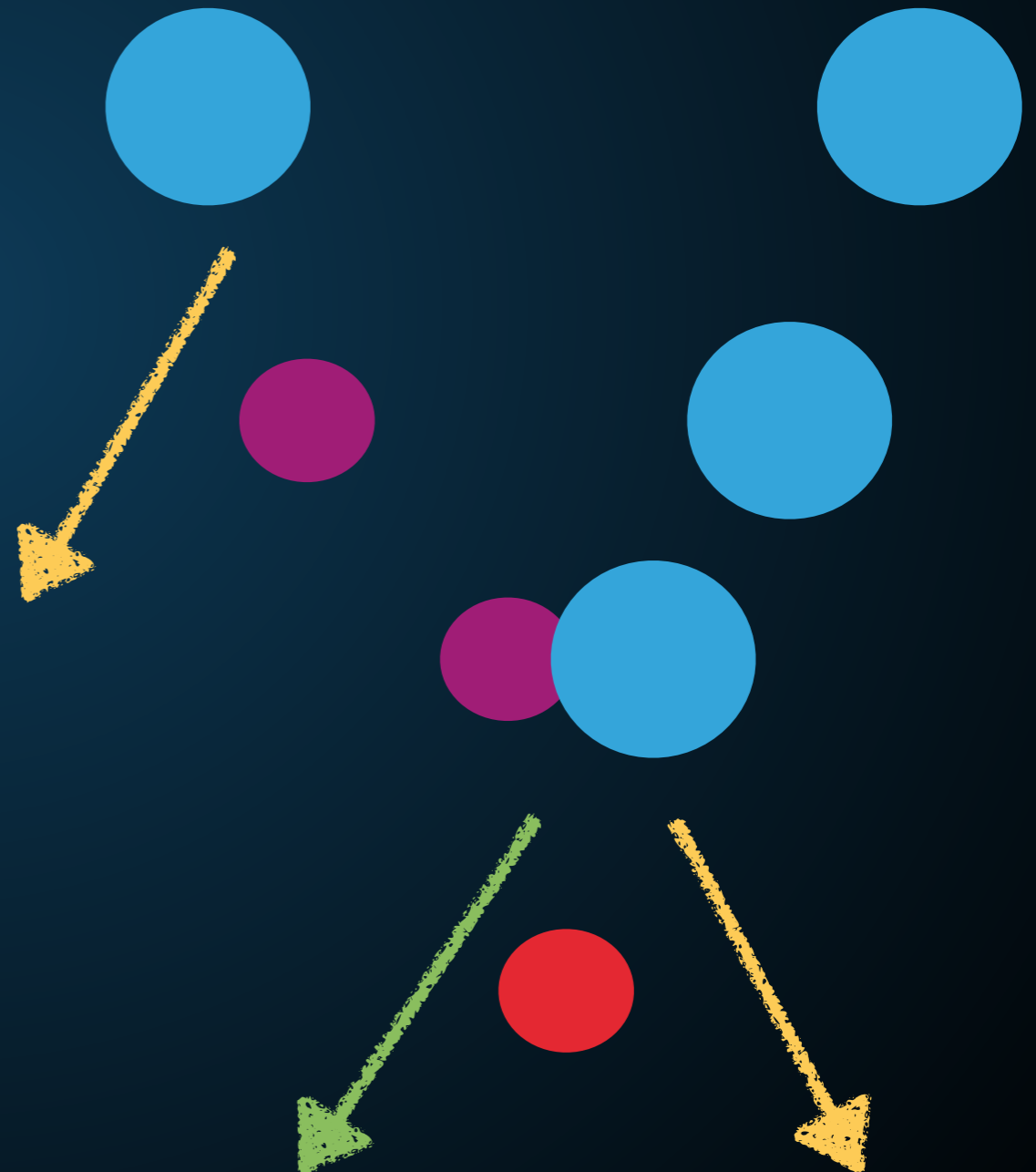

# DISSOCIATION OF EM AND GRAVITATIONAL SIGNATURES

- ▶ Disassociation of electromagnetic and gravitational wave signatures

## No DM Induced Collapse

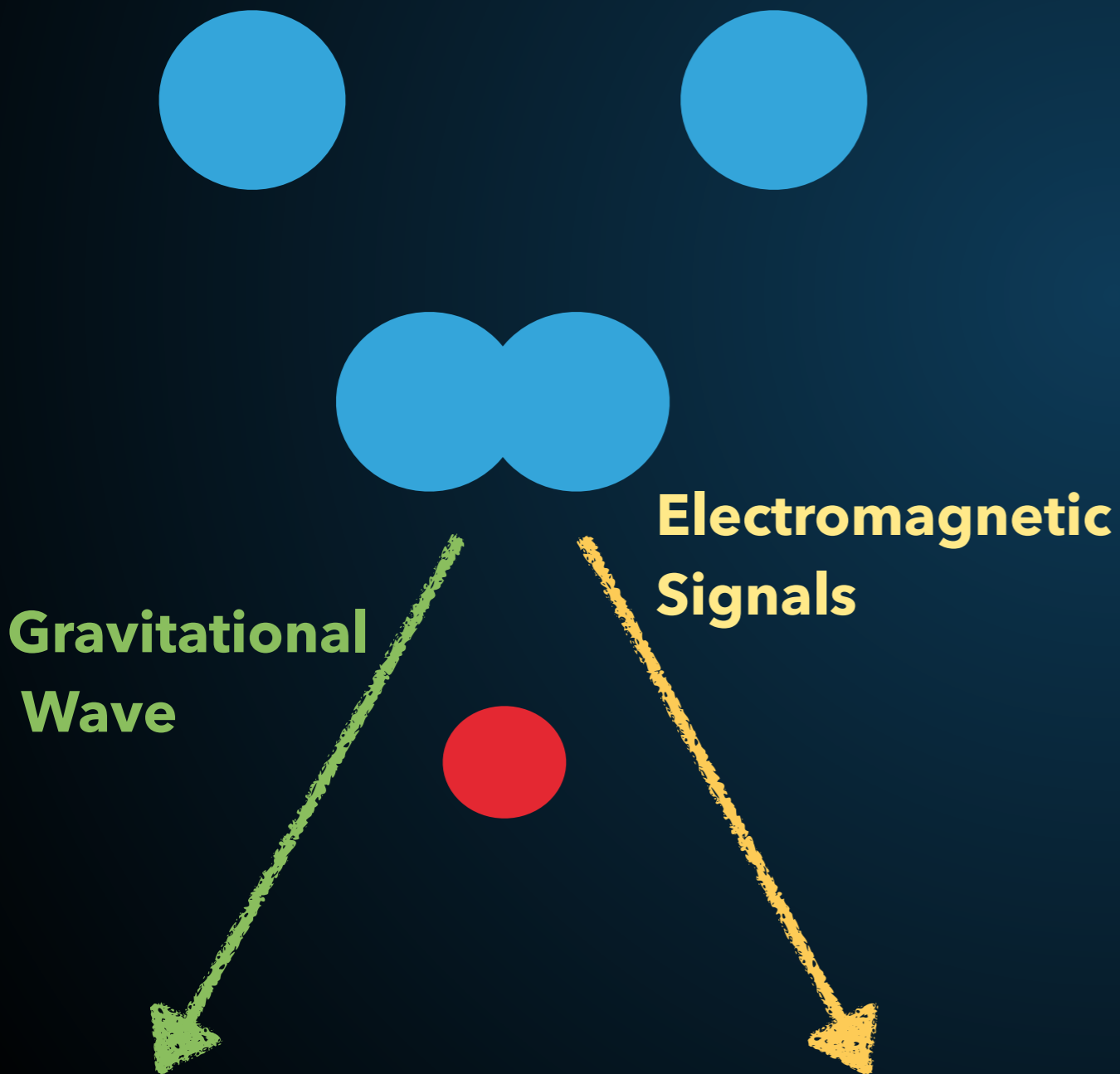

## DM Induced Collapse

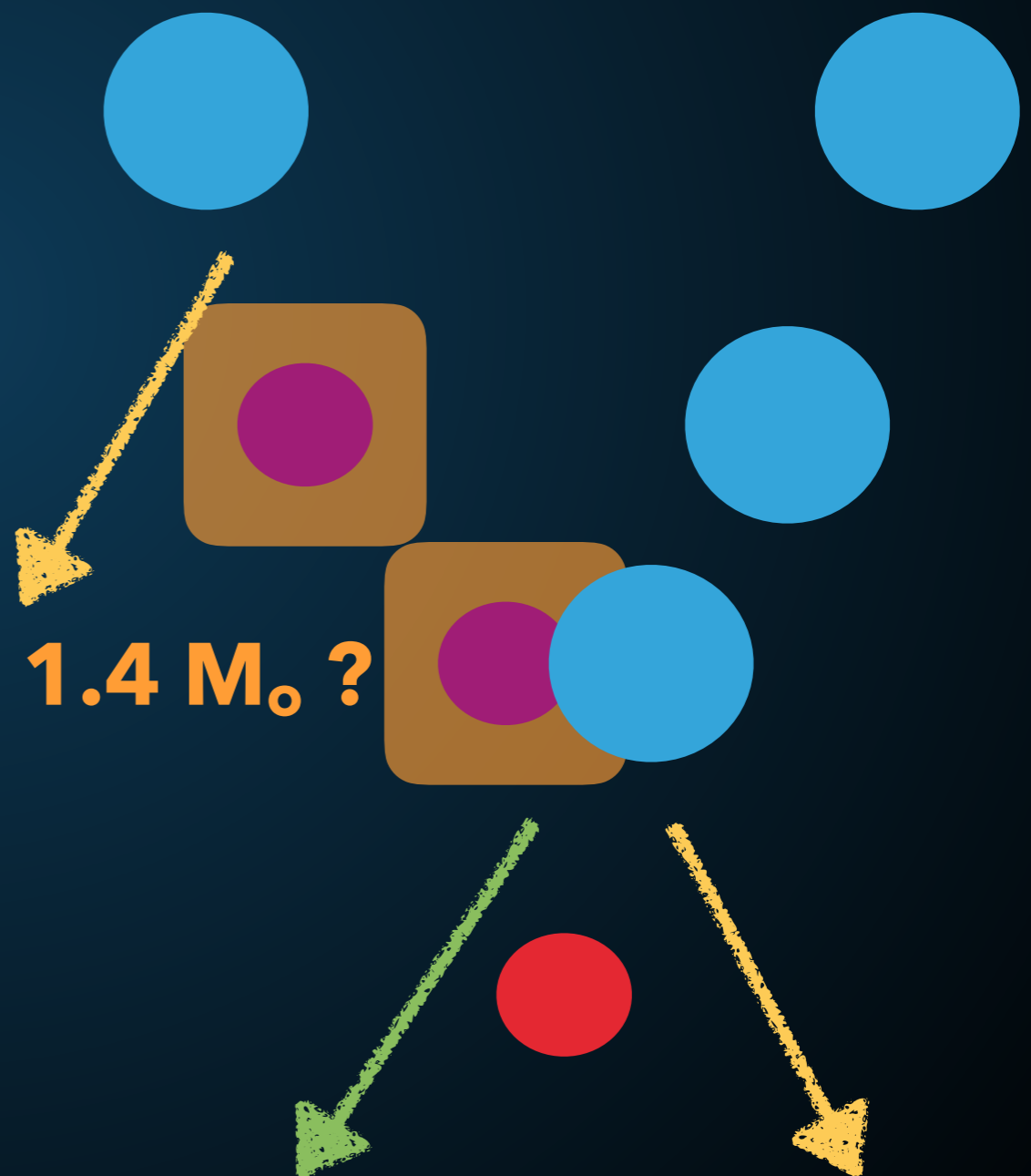

- ▶ **Merger Kilonovae** - Bright r-process afterglows of NS-NS binary mergers.
- ▶ **Quiet Kilonovae** - Possible r-process afterglows of DM induced neutron star collapse
- ▶ **Black Mergers** - Interactions that look like NS-NS binaries to LIGO, but both NS have already collapsed, and thus no electromagnetic counterpart is found.



# GRAVITATIONAL WAVES FROM SINGLE STAR COLLAPSE

## ▶ Gravitational Waves from DM induced collapse

$$h_c \sim 5 \times 10^{-22} \left( \frac{M}{M_\odot} \right) \left( \frac{10 \text{ kpc}}{D} \right) @ 531 \text{ Hz},$$

Baiotti et al. (gr-qc/0701043)

▶ Single NS collapse models have been considered (primarily from accretion induced collapse).

▶ DM induced NS collapse observable throughout the Milky Way ( $0.01 \text{ yr}^{-1}$  ?)

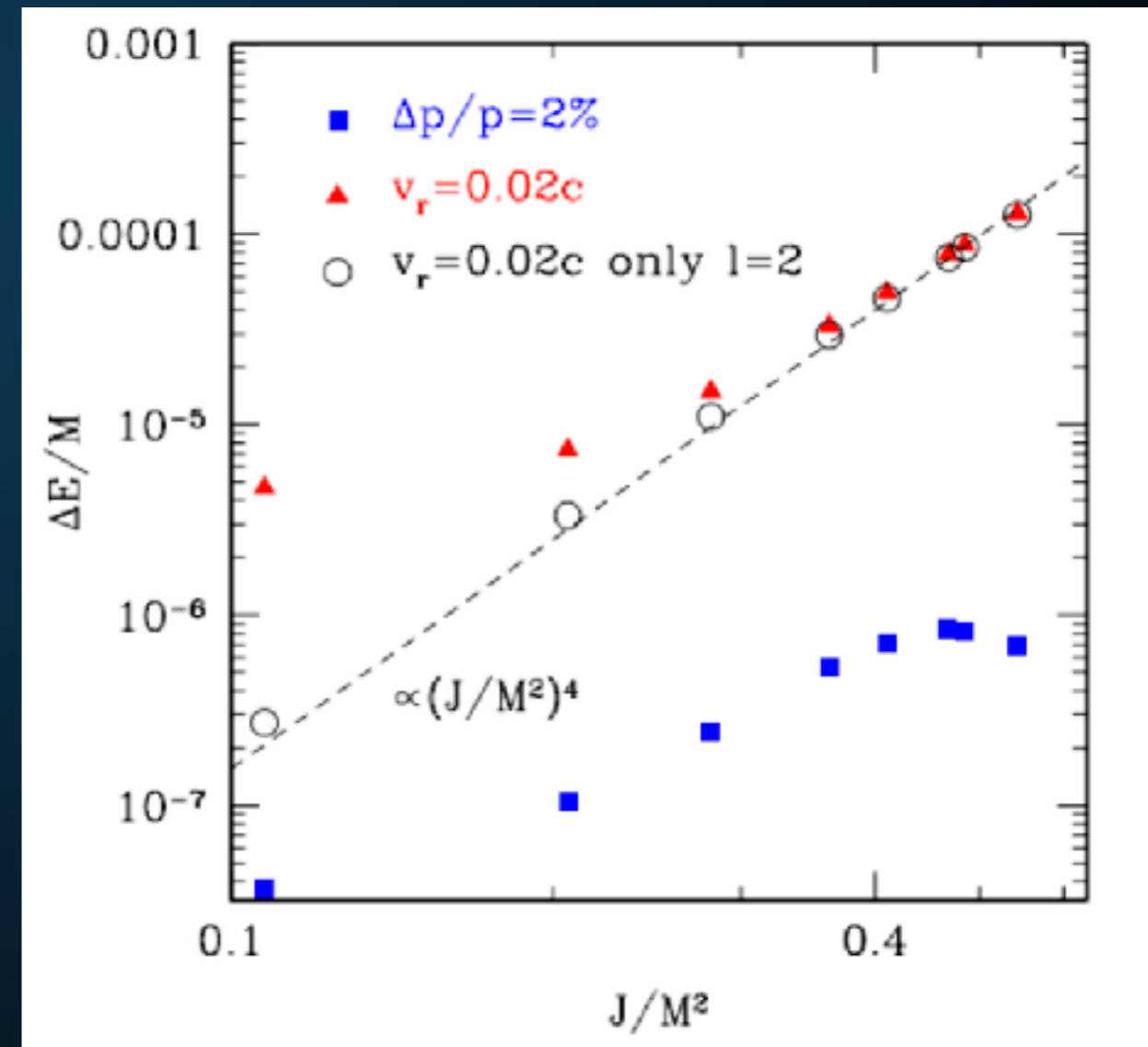







# POSSIBLE SIGNATURES OF DARK MATTER INTERACTIONS

---

- ▶ **Hard to discover dark matter with a dog that didn't bark....**
- ▶ **Can we find a positive signature of dark matter induced neutron star collapse?**
  - ▶ **Gravitational wave signatures**
  - ▶ **Electromagnetic signatures!**
    - ▶ **Fast Radio Bursts**
    - ▶ **Kilonovae**
    - ▶ **r-process enrichment**

# R-PROCESS ENRICHMENT OF DWARF SPHEROIDAL GALAXIES

## The Origin of the Solar System Elements

1 H	big bang fusion 										cosmic ray fission 					2 He						
3 Li	4 Be	merging neutron stars 										exploding massive stars 					5 B	6 C	7 N	8 O	9 F	10 Ne
11 Na	12 Mg	dying low mass stars 										exploding white dwarfs 					13 Al	14 Si	15 P	16 S	17 Cl	18 Ar
19 K	20 Ca	21 Sc	22 Ti	23 V	24 Cr	25 Mn	26 Fe	27 Co	28 Ni	29 Cu	30 Zn	31 Ga	32 Ge	33 As	34 Se	35 Br	36 Kr					
37 Rb	38 Sr	39 Y	40 Zr	41 Nb	42 Mo	43 Tc	44 Ru	45 Rh	46 Pd	47 Ag	48 Cd	49 In	50 Sn	51 Sb	52 Te	53 I	54 Xe					
55 Cs	56 Ba		72 Hf	73 Ta	74 W	75 Re	76 Os	77 Ir	78 Pt	79 Au	80 Hg	81 Tl	82 Pb	83 Bi	84 Po	85 At	86 Rn					
87 Fr	88 Ra																					
			57 La	58 Ce	59 Pr	60 Nd	61 Pm	62 Sm	63 Eu	64 Gd	65 Tb	66 Dy	67 Ho	68 Er	69 Tm	70 Yb	71 Lu					
			89 Ac	90 Th	91 Pa	92 U																

Graphic created by Jennifer Johnson

Astronomical Image Credits:  
ESA/NASA/AASNova



# R-PROCESS ENRICHMENT OF DWARF SPHEROIDAL GALAXIES

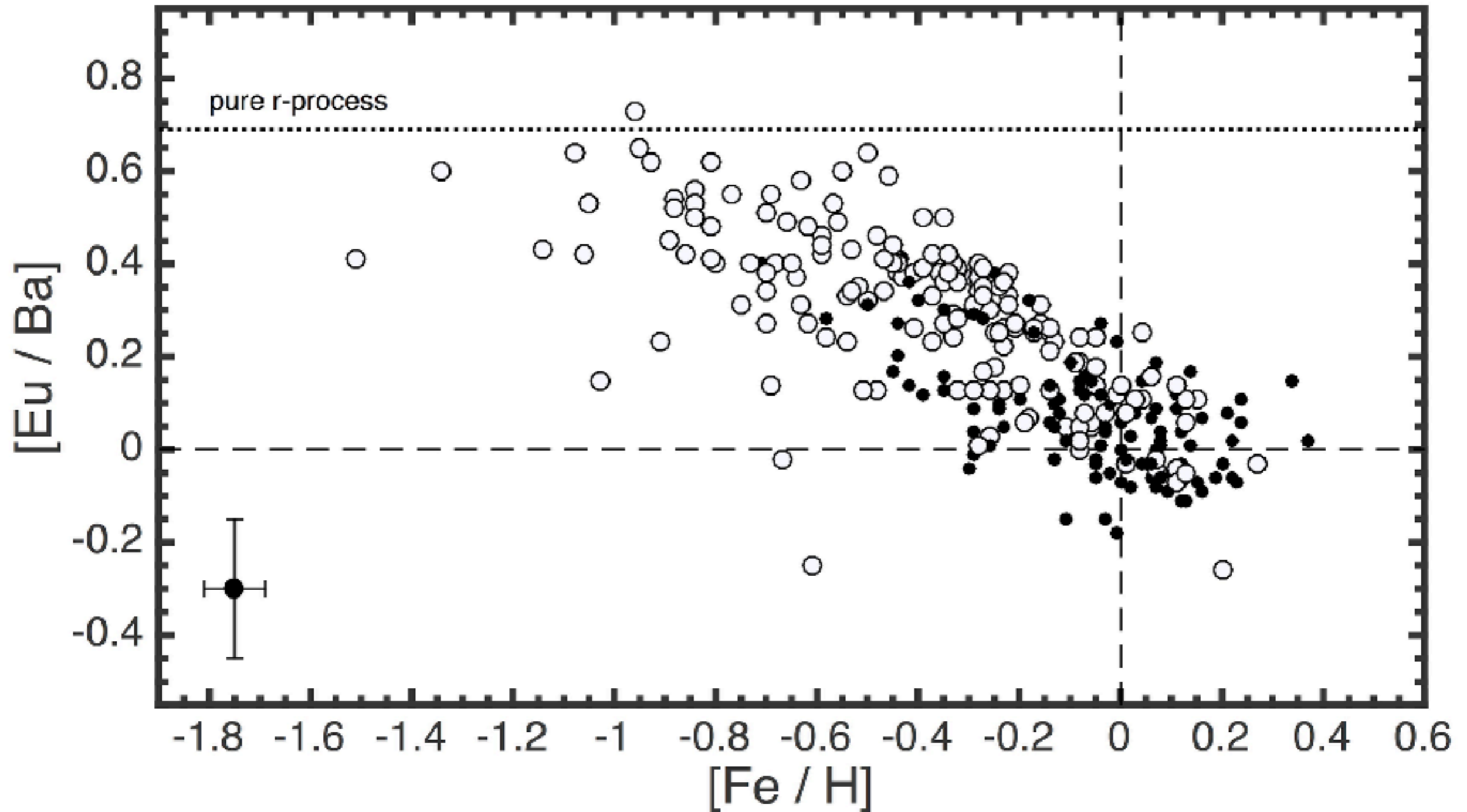

- ▶ This can be done in steady state - determining the *galactic archeology* of chemical evolution...

## LETTER

doi:10.1038/nature24291

# Optical emission from a kilonova following a gravitational-wave-detected neutron-star merger

Iair Arcavi<sup>1,2</sup>, Griffin Hosseinzadeh<sup>1,2</sup>, D. Andrew Howell<sup>1,2</sup>, Curtis McCully<sup>1,2</sup>, Dovi Poznanski<sup>3</sup>, Daniel Kasen<sup>4,5</sup>, Jennifer Barnes<sup>6</sup>, Michael Zaltzman<sup>3</sup>, Sergiy Vasylyev<sup>1,2</sup>, Dan Maoz<sup>3</sup> & Stefano Valenti<sup>7</sup>

The merger of two neutron stars has been predicted to produce an optical-infrared transient (lasting a few days) known as a 'kilonova', powered by the radioactive decay of neutron-rich species synthesized in the merger<sup>1–5</sup>. Evidence that short  $\gamma$ -ray bursts also arise from neutron-star mergers has been accumulating<sup>6–8</sup>. In models<sup>2,9</sup> of such mergers, a small amount of mass ( $10^{-4}$ – $10^{-2}$  solar masses) with a low electron fraction is ejected at high velocities (0.1–0.3 times light speed) or carried out by winds from an accretion disk formed around the newly merged object<sup>10,11</sup>. This mass is expected to undergo rapid neutron capture (r-process) nucleosynthesis, leading to the formation of radioactive elements that release energy as they decay, powering an electromagnetic transient<sup>1–3,9–14</sup>. A large uncertainty in the composition of the newly synthesized material leads to various expected colours, durations and luminosities for such transients<sup>11–14</sup>. Observational evidence for kilonovae has so far been inconclusive because it was based on cases<sup>15–19</sup> of moderate excess emission detected in the afterglows of  $\gamma$ -ray bursts. Here we report optical to near-infrared observations

reveal an initial blue excess, with fast optical fading and reddening. Using numerical models<sup>21</sup>, we conclude that our data are broadly consistent with a light curve powered by a few hundredths of a solar mass of low-opacity material corresponding to lanthanide-poor (a fraction of  $10^{-4.5}$  by mass) ejecta.

GW170817 was detected<sup>22</sup> by the LIGO<sup>23</sup> and Virgo<sup>24</sup> gravitational-wave detectors on 17 August 2017 at 12:41:04 (universal time (UT) is used throughout; we adopt this as the time of the merger). Approximately two seconds later, a low-luminosity short-duration  $\gamma$ -ray burst, GRB 170817A, was detected<sup>25</sup> by the Gamma-ray Burst Monitor (GBM) on board the Fermi satellite. A few hours later, the gravitational-wave signal was robustly identified as the signature of a binary neutron-star merger  $40 \pm 8$  Mpc away in a region of the sky coincident with the Fermi localization of the  $\gamma$ -ray burst<sup>26</sup> (Fig. 1).

Shortly after receiving the gravitational-wave localization, we activated our pre-approved program to search for an optical counterpart with the Las Cumbres Observatory (LCO) global network of robotic telescopes<sup>27</sup>. Given the size of the LIGO–Virgo localization



## **HOW WOULD WE DIFFERENTIATE A DARK MATTER CONTRIBUTION?**

---

- ▶ 1.) Look in regions with where the dark matter signal should be dominant.**
- ▶ 2.) Look at the distribution of events in galactic systems.**



- ▶ **Reticulum II dSph**
  - ▶ **Discovered by DES in 2015**
  - ▶ **Spectroscopic follow-up determined r-process abundances.**
  - ▶ **Large r-process abundance, but low metallicity!**
- ▶ **Points to a rare formation channel (NS mergers)**

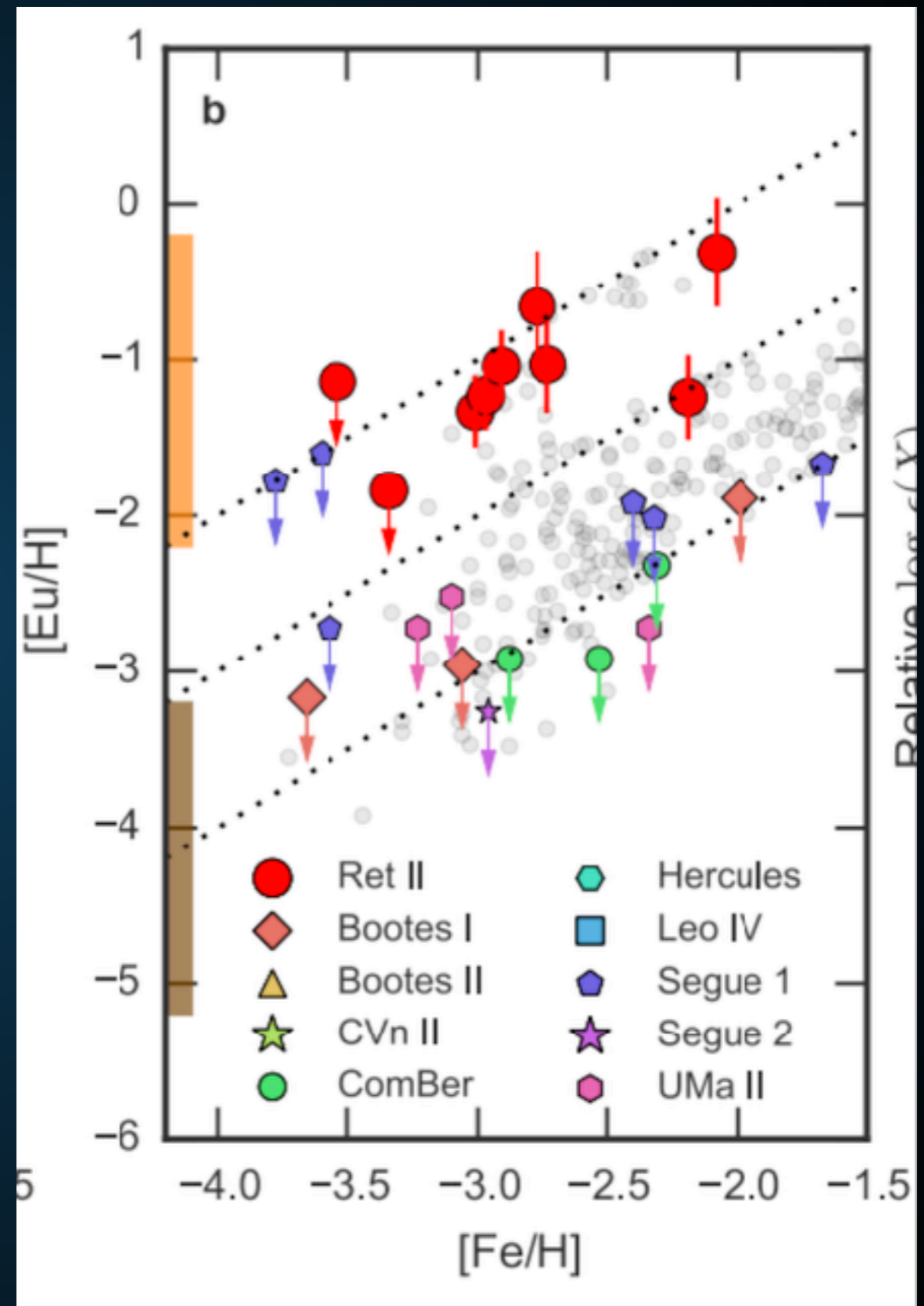

- ▶ The dispersion velocity in dwarfs is also small.
  - ▶ Reticulum II:  $3.3 \pm 0.7 \text{ km s}^{-1}$  (Simon et al. 2015)
- ▶ Dark matter accumulation rate scales inversely with velocity:

$$\dot{m}_x = \pi \rho_x \frac{2GM R}{v_x} \left(1 - \frac{2GM}{R}\right)^{-1}$$
$$\simeq \frac{10^{26} \text{ GeV}}{\text{s}} \left(\frac{\rho_x}{\text{GeV/cm}^3}\right) \left(\frac{200 \text{ km/s}}{v_x}\right),$$

- ▶ Dwarf Spheroidal Galaxies are an optimal laboratory for asymmetric dark matter detection.

- ▶ **Normalize the nuclear cross-section to the missing pulsar problem.**
- ▶ **Supernovae produce ~100 events.**
- ▶ **Mergers produce ~0.0005 events**
- ▶ **DM induced collapse produces ~0.1-3 events.**

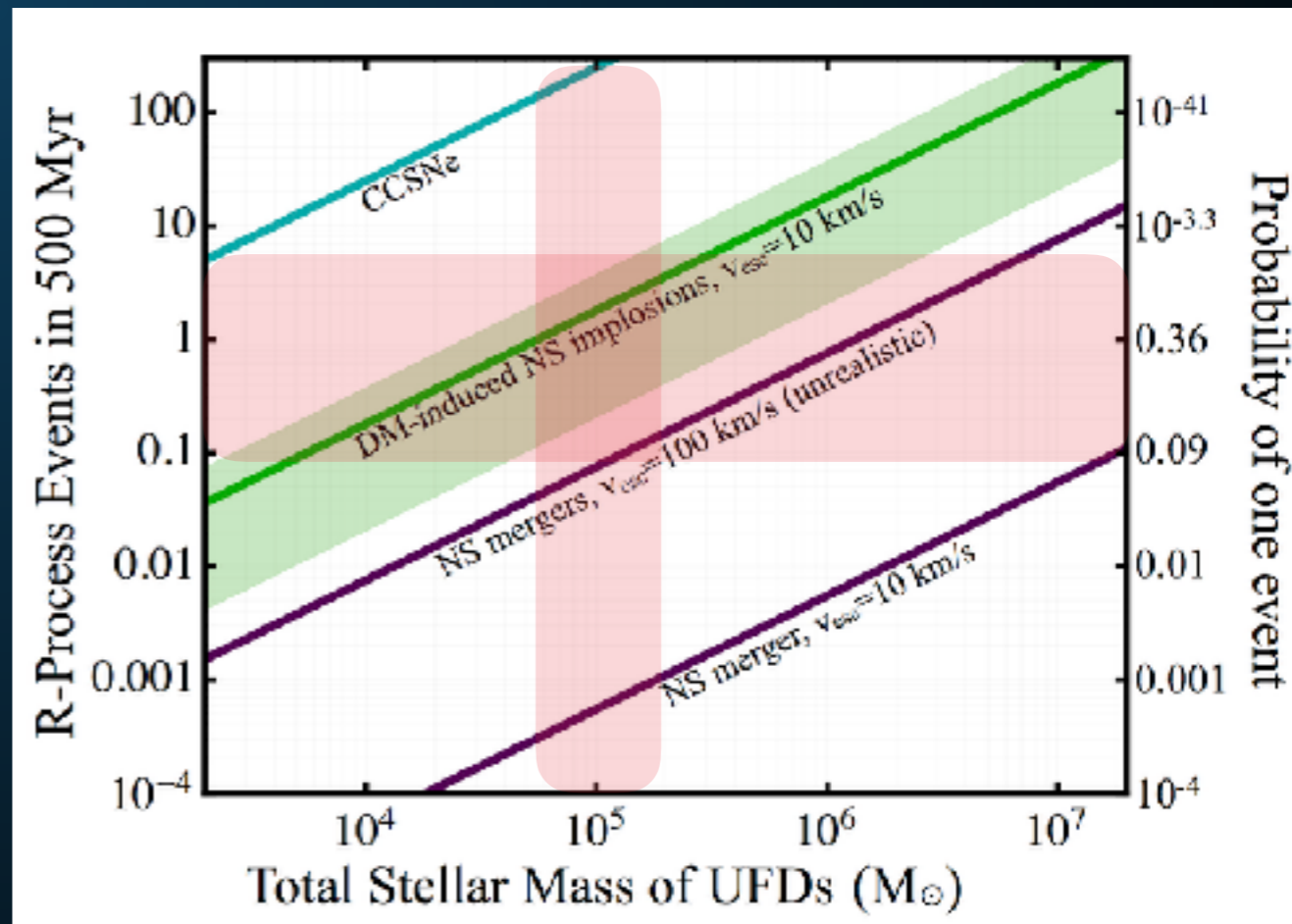
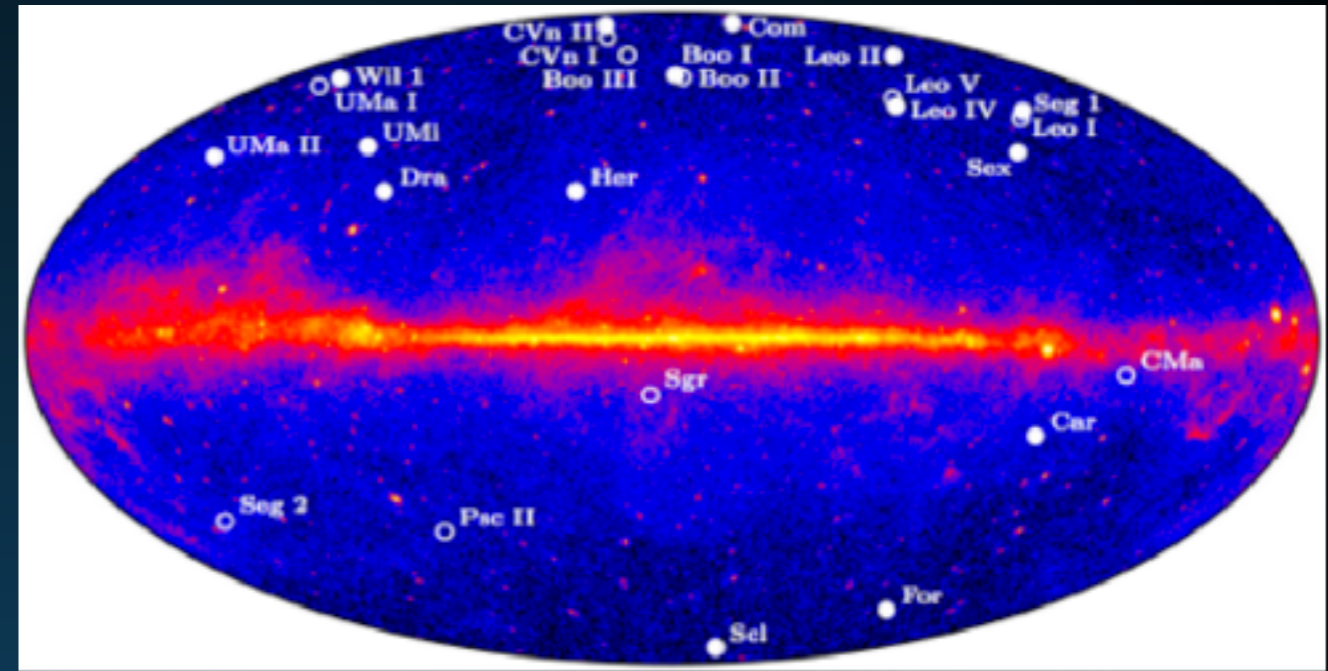



## TWO REGIMES

---

- ▶ **1.) Look in regions with where the dark matter signal should be dominant.**
- ▶ **2.) Look at the distribution of events in galactic systems.**
  - ▶ **Separate individual events by looking for transients!**

# DARK MATTER PROFILES

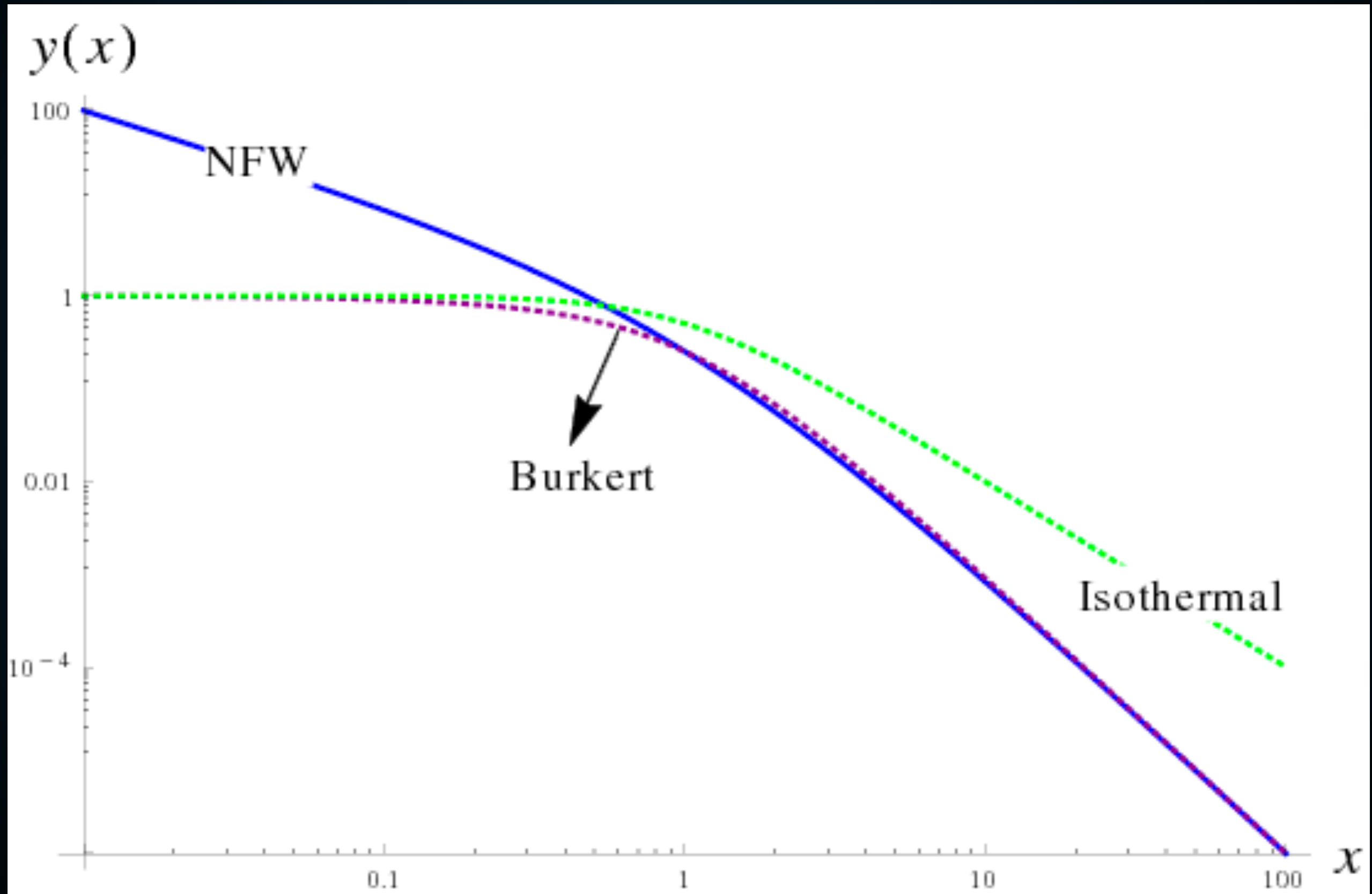

- ▶ Merger Kilonovae - Bright r-process afterglows of NS-NS binary mergers. (inversely proportional to  $\rho_{\text{DM}}$ ).
- ▶ Quiet Kilonovae - Possible r-process afterglows of DM induced neutron star collapse (proportional to  $\rho_{\text{DM}}$ ).
- ▶ Black Mergers - Interactions that look like NS-NS binaries to LIGO, but both NS have already collapsed, and thus no electromagnetic counterpart is found (proportional to  $\rho_{\text{DM}}$ ).



# A USEFUL UNIT

$$M_{DM} \propto \sigma_{xp}$$



particle physics

$t_{NS}$

position dependent

$$\left( \frac{p_x}{v_x} \right)$$

in any  
p.p. model

$$t_{imp}(r) \propto \frac{p_x}{v_x}$$

- ▶ The Dark Matter distribution determines the stellar collapse rate.
- ▶ The morphology of DM induced mergers differs from baryonic ones.
- ▶ Bright kilo novae associated with NS-NS mergers should be detected, but only in the outskirts of galaxies.

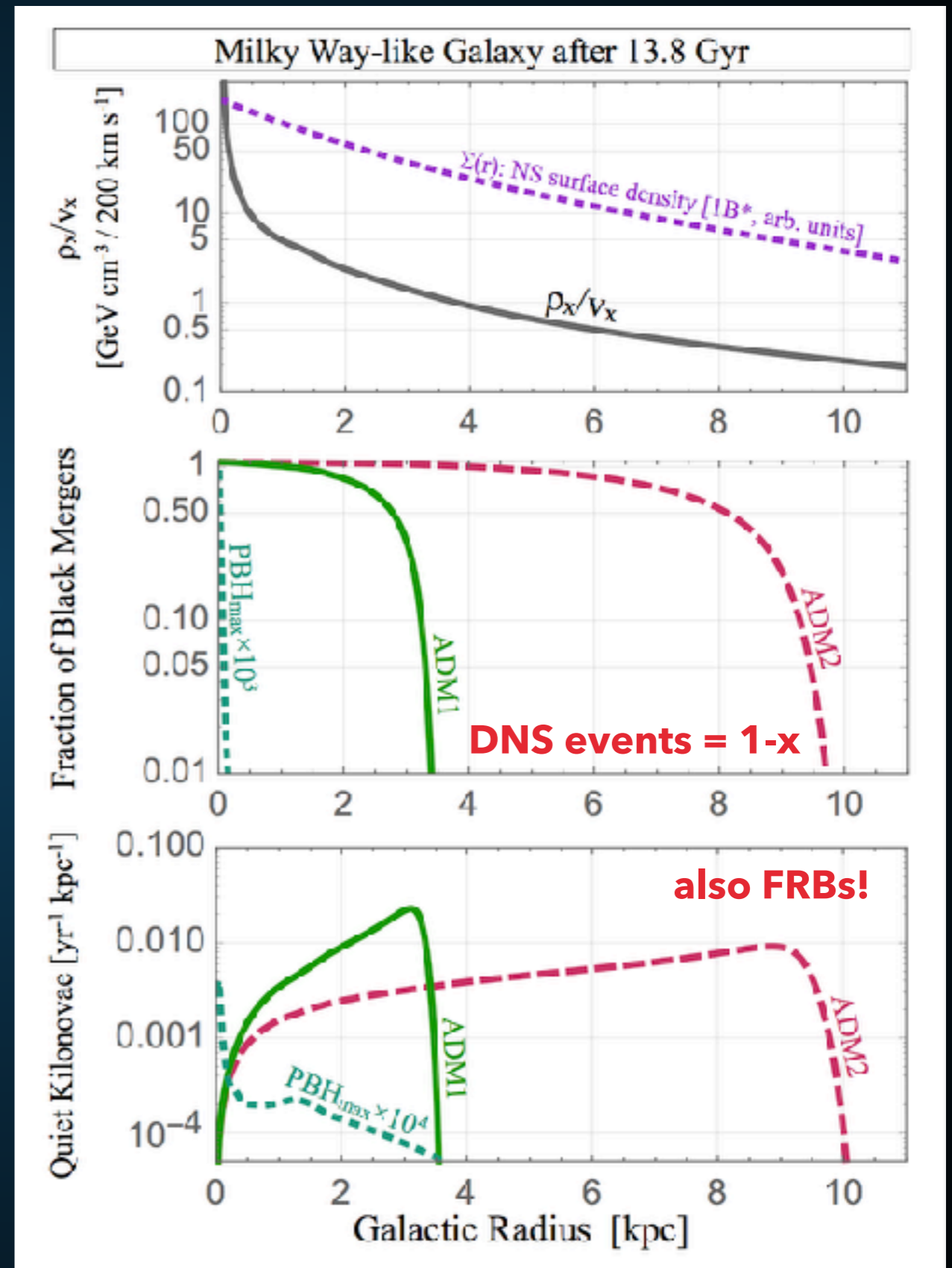

- ▶ By localizing either merger kilonovae or fast-radio bursts, can differentiate models where DM collapses NS.
- ▶ FRB instruments such as CHIME expected to detect ~1000 FRBs in the next few years.

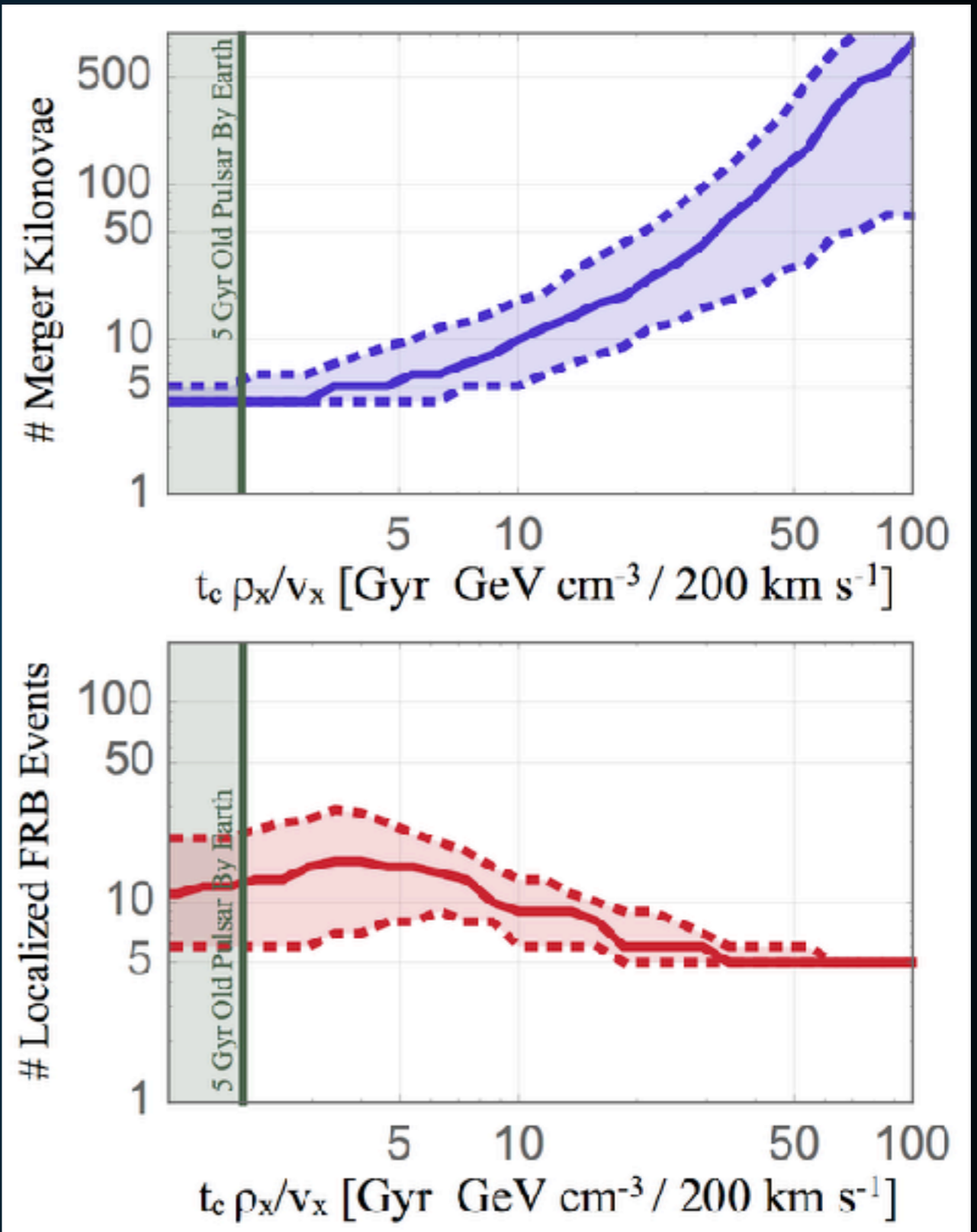



## DISCUSSION AND CONCLUSIONS

---

- ▶ **Asymmetric dark matter models naturally produce neutron star collapse in regions with high dark matter density and low velocity dispersion.**
- ▶ **There are a number of astrophysical signals (and hints!) of such interactions.**
- ▶ **Future observations are likely to definitively prove, or rule out, this class of models.**

# DISCUSSION AND CONCLUSIONS

---

▶ **Extra Slides**

# GRAVITATIONAL WAVES FROM BINARY LM-NS MERGERS

- ▶ Anomalies in the tidal strain of binary neutron star mergers.
- ▶ DM induced NS collapse produces a population of  $1.4 M_{\odot}$  black holes.
- ▶ Can potentially see differences in merger and ring-down, but not presently feasible.

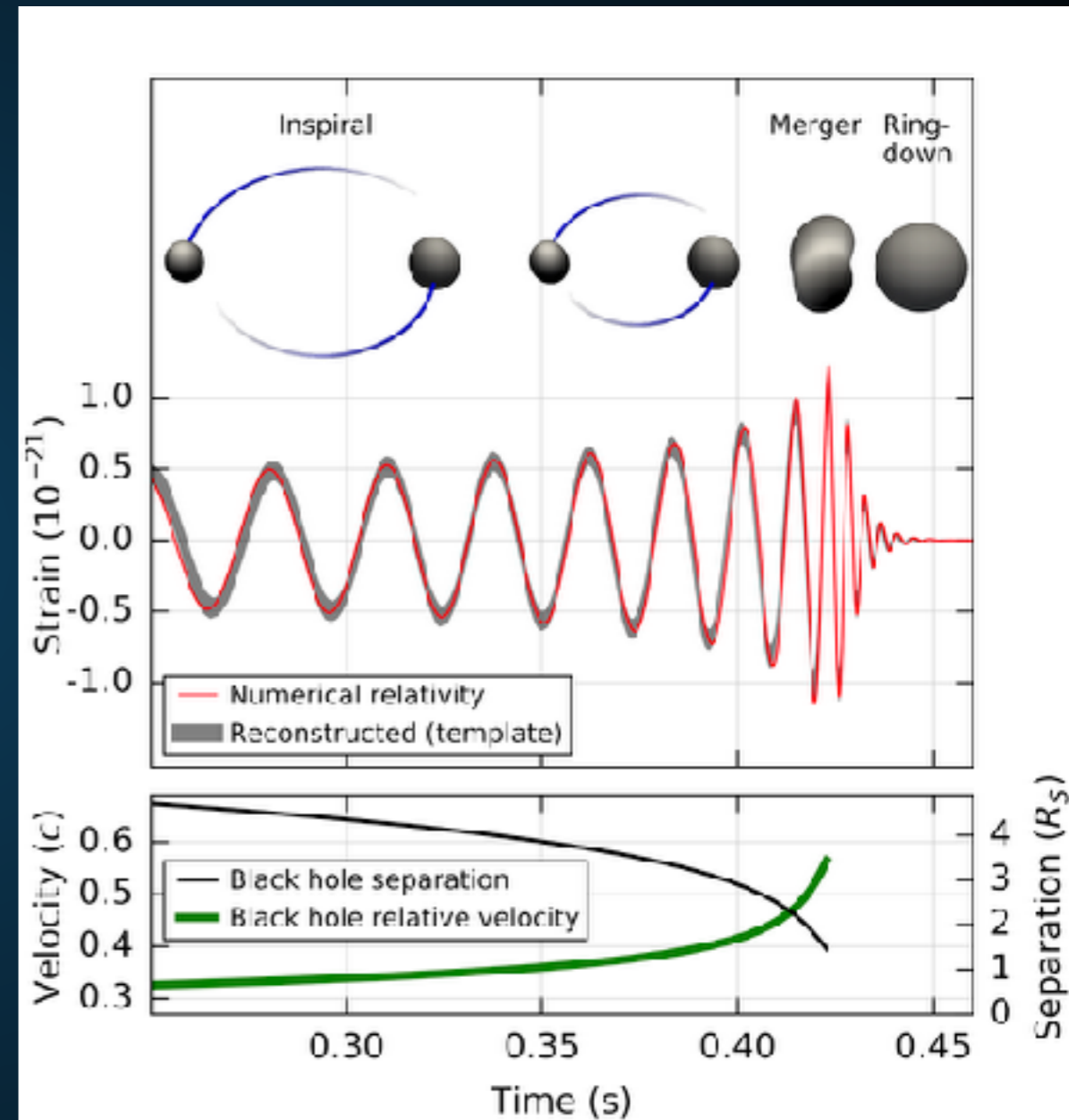
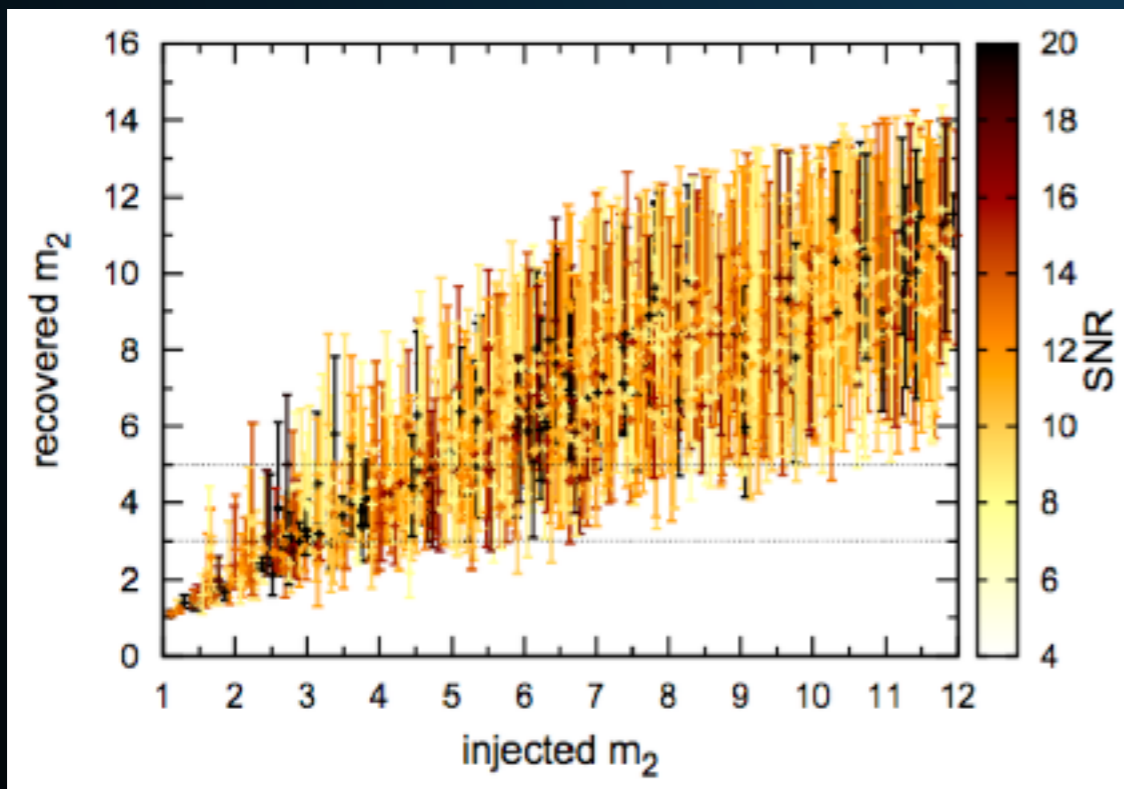



# MIND THE MASS GAP - THE LOWEST MASS BLACK HOLES

Belczynski et al. (2011, 1110.1635)

- ▶ Observations have found a significant gap between the smallest black holes and the heaviest neutron stars.

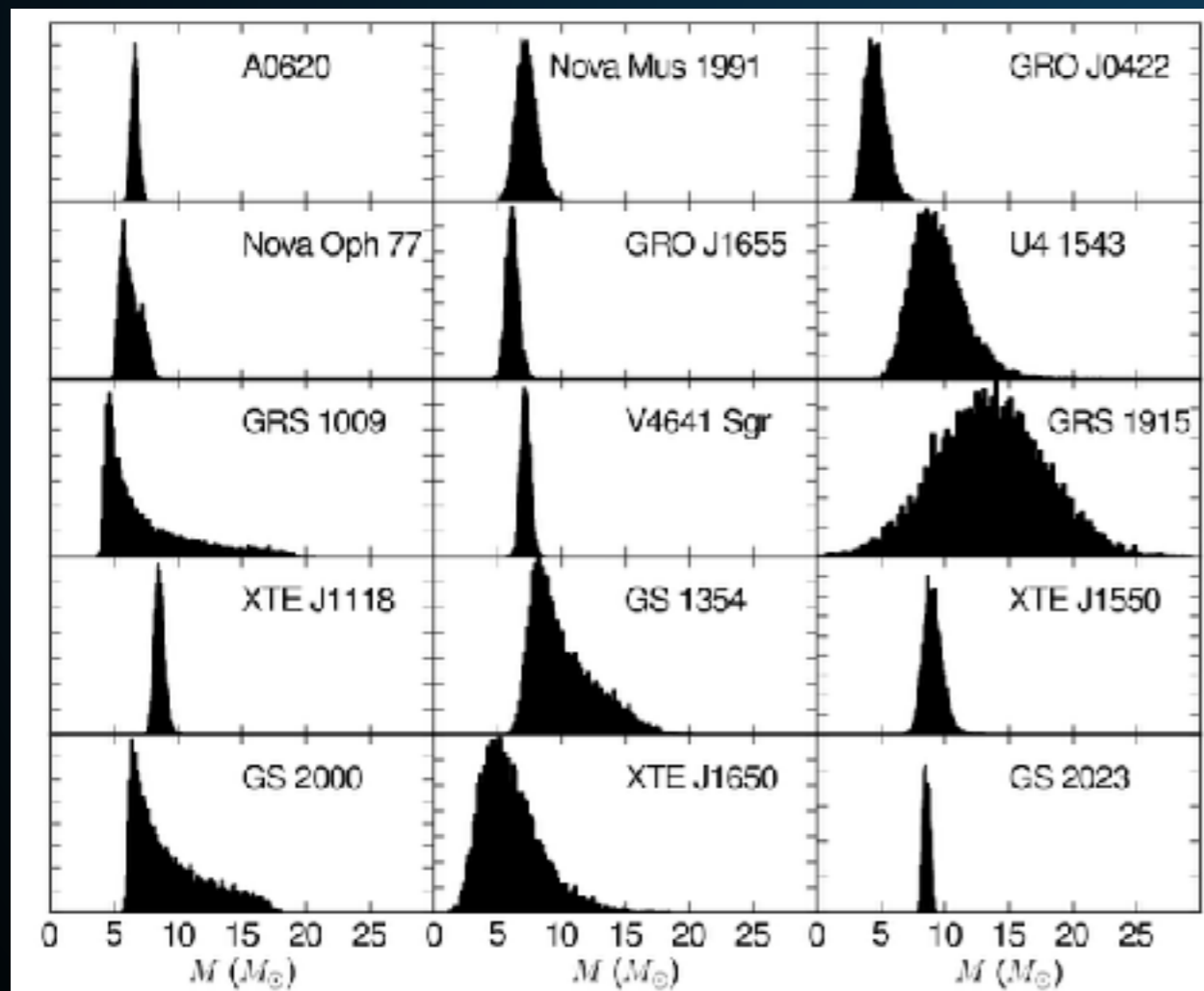

Farr et al. (2010, 1011.1459)

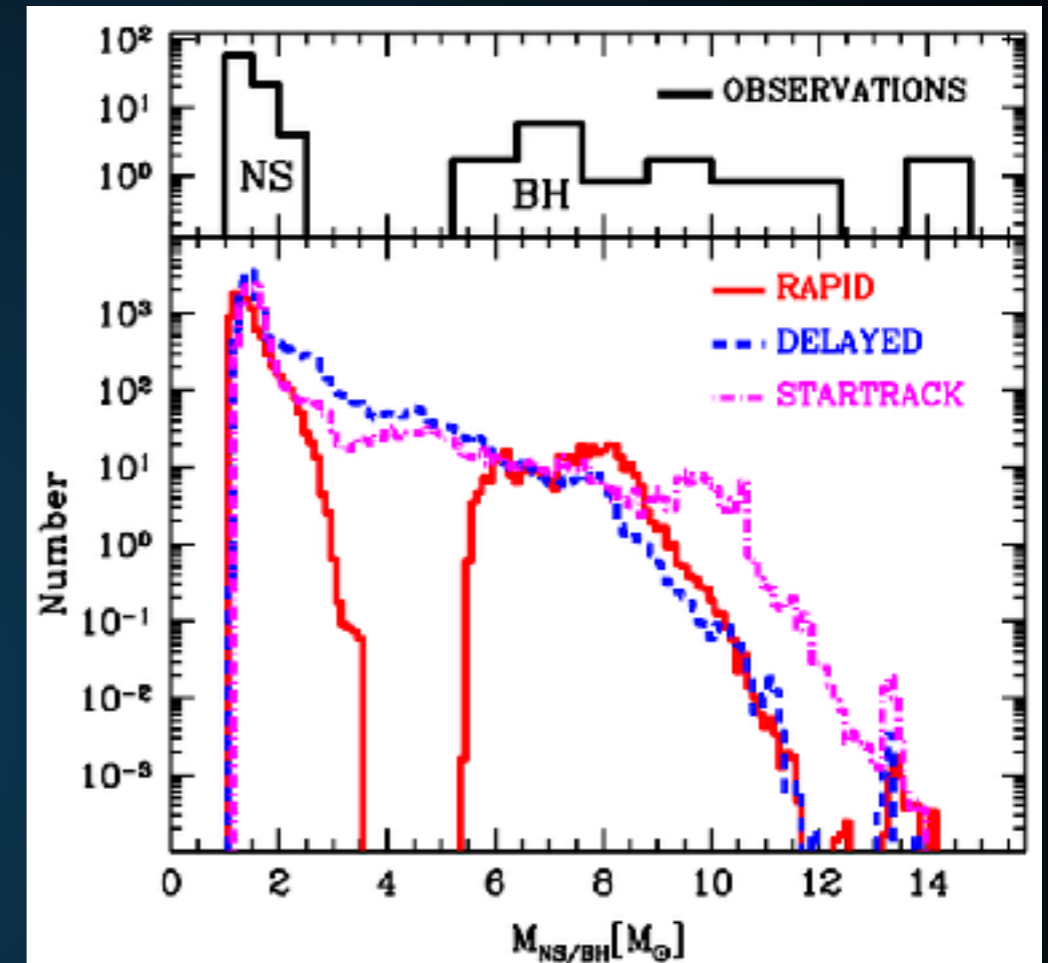

- ▶ This is often used as a metric for NS identification.

- ▶ Anomalous
- ▶ DM
- ▶ pro
- ▶  $M_{\odot}$
- ▶ Can
- ▶ in m
- ▶ not

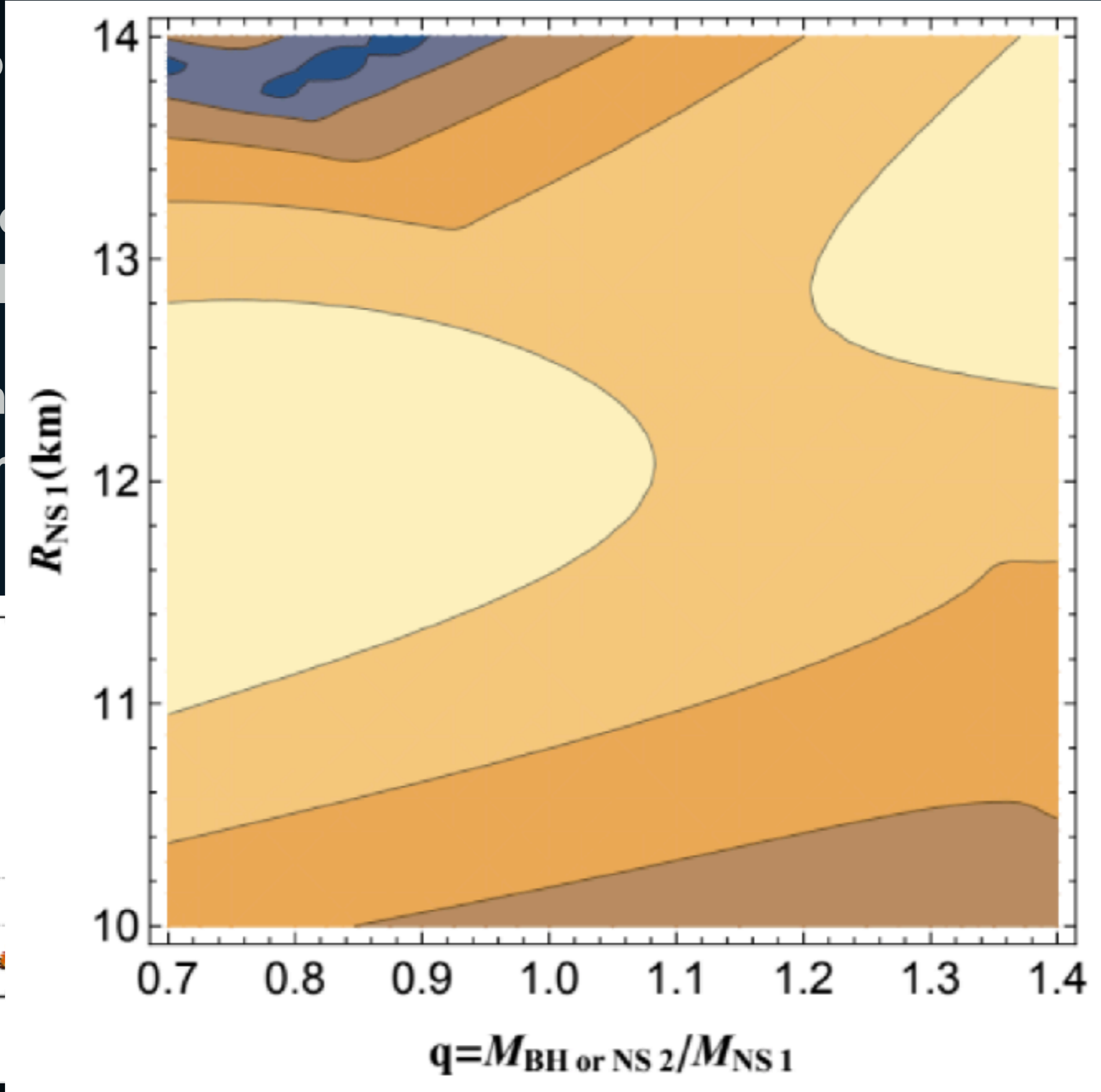
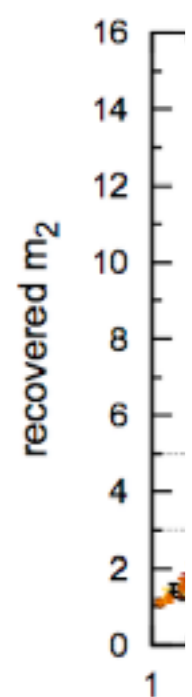

S.



- ▶ Mergers require kicks to move binary from widely separated supergiant system to tightly bound NS-NS binary.

$$\tau_m(m_1, m_2, w, b) = \frac{3}{85} \frac{a_0^4}{m_{\text{tot}}^3 \eta} (1 - e_0^2)^{7/2}.$$

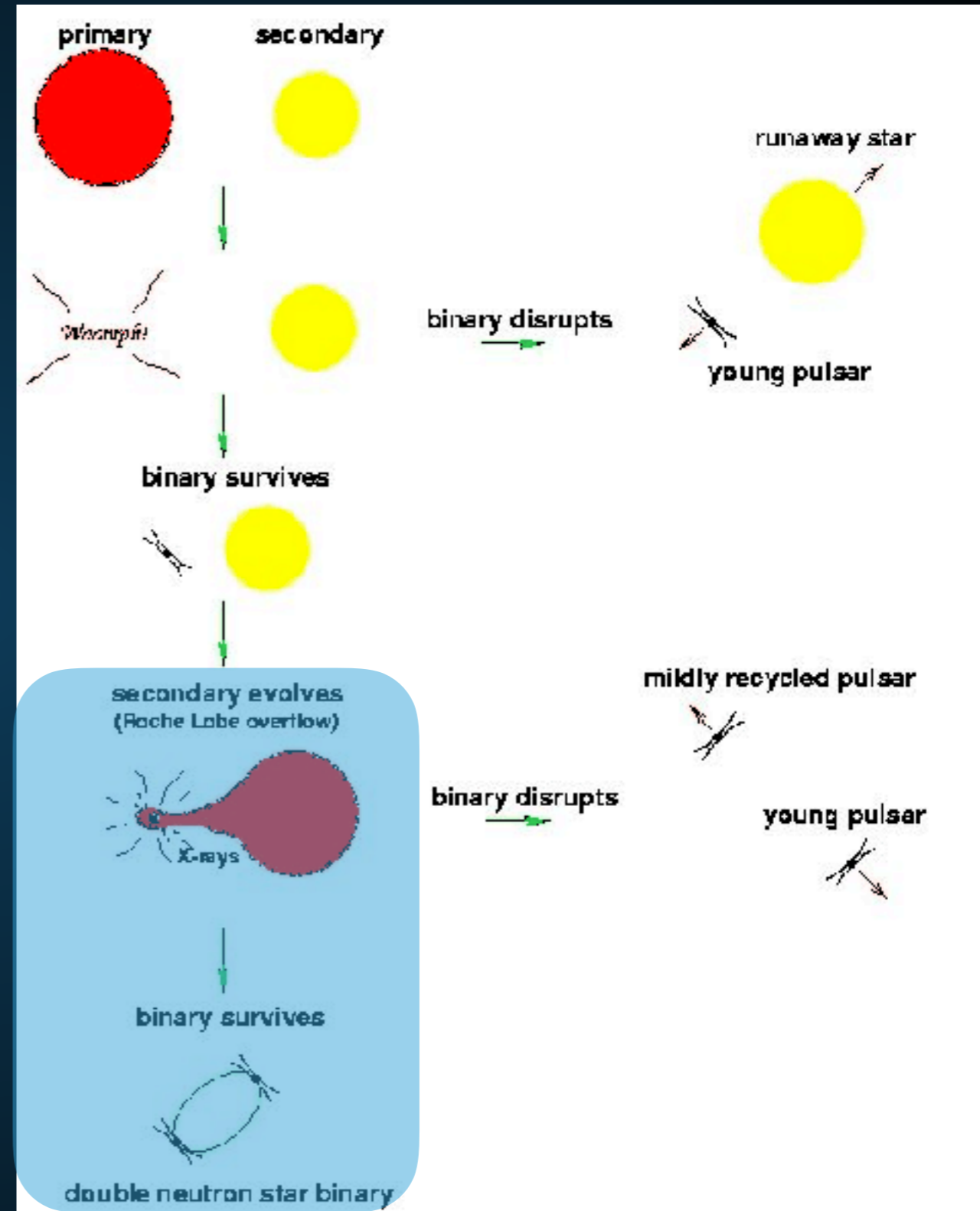
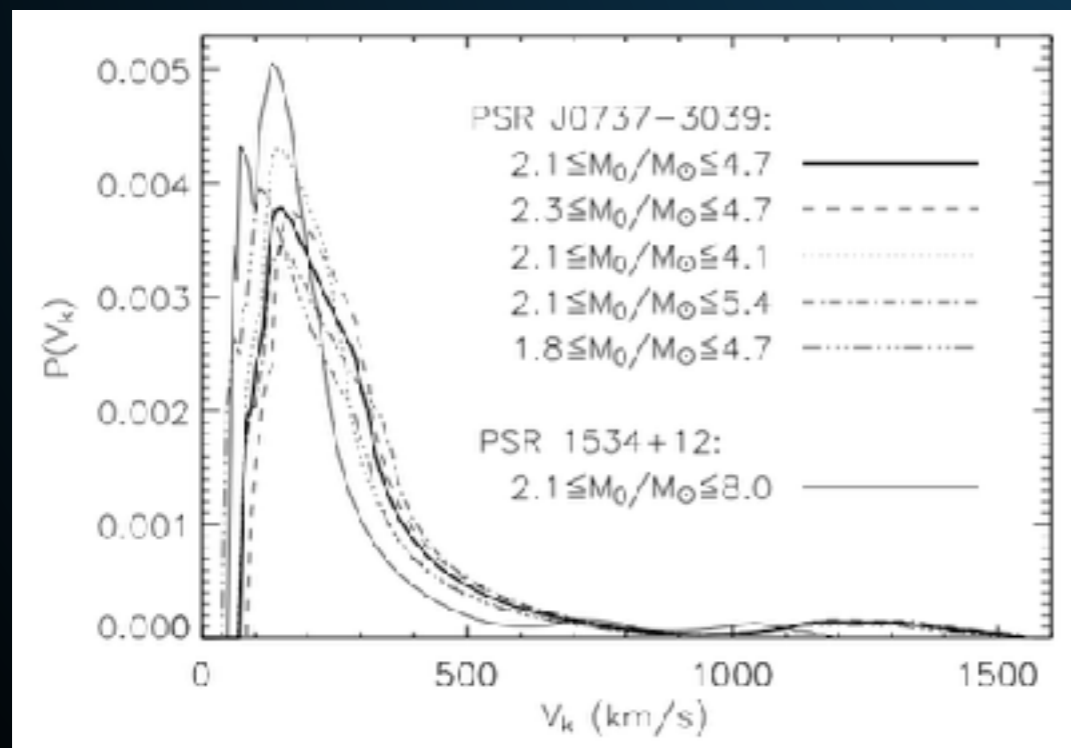



- ▶ Can roughly estimate the maximal r-process production rate via energetics:

$$E_i \approx 3GM_{\text{NS}}^2(R_{\text{Sch.}}^{-1} - R_{\text{NS}}^{-1})/5 = 3 \times 10^{57} (M_{\text{NS}}/1.5M_{\odot}) \text{ GeV},$$

- ▶ This energy can propel neutrons from the NS surface at  $v = 0.7c$ . The maximum mass that can be lost is:

$$M_{ej} \leq m_n \frac{E_i}{E_a} \lesssim 0.2 \left( \frac{M_{\text{NS}}}{1.5M_{\odot}} \right) \left( \frac{1.4}{\gamma(v_{ej})} \right) M_{\odot}.$$

- ▶ The actual r-process enrichment depends on the quantity and density of neutrons which escape in the implosion. Computational models are needed.

- ▶ How much r-process enrichment per dark matter induced collapse?

- ▶ Currently abundance

- ▶ Yields between  $5 \times 10^{-5} M_{\odot}$  and  $10^{-3} M_{\odot}$  can explain Milky Way r-process abundance.

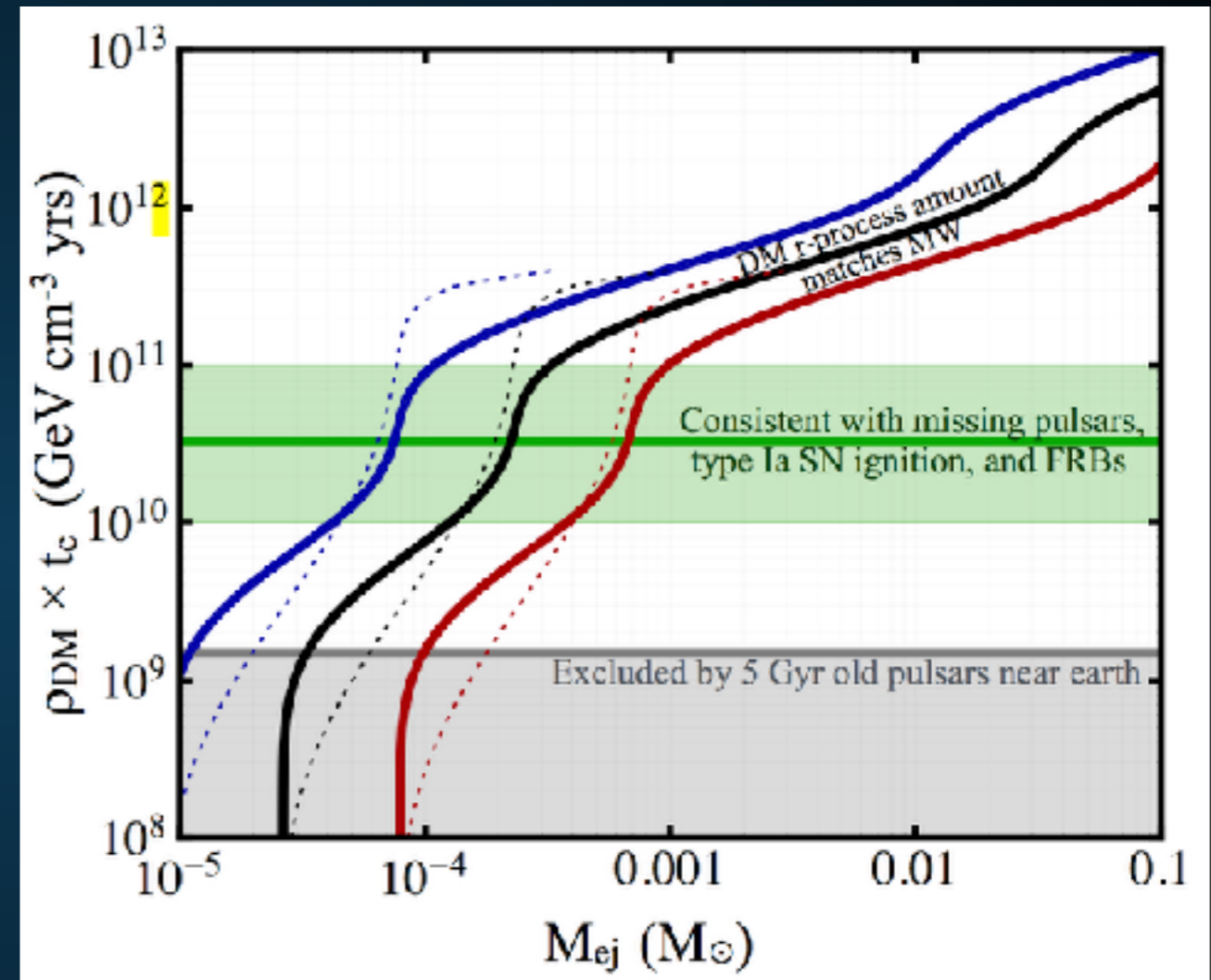

- ▶ Significant uncertainties in r-process element transport throughout the Milky Way.

Model	NS-NS	NS-BH	BH-BH	LM-BH	NS Im.	Im./ $t_u$
Non-Imp.	1e-4	3e-6	4e-7	0	0	0
ADM1	3e-5	9e-7	4e-7	7e-5	4e-2	7e8
ADM2	7e-5	2e-6	4e-7	3e-5	3e-2	3e8
PBH <sub>max</sub>	1e-4	3e-6	4e-7	4e-11	1e-7	400

- ▶ Utilizing models normalized to the missing pulsar problem, we find that the dark merger rate should be significant!
- ▶ **Difficult to argue that you have found dark matter by not seeing something that you should....**



# R-PROCESS ENRICHMENT OF DWARF SPHEROIDAL GALAXIES

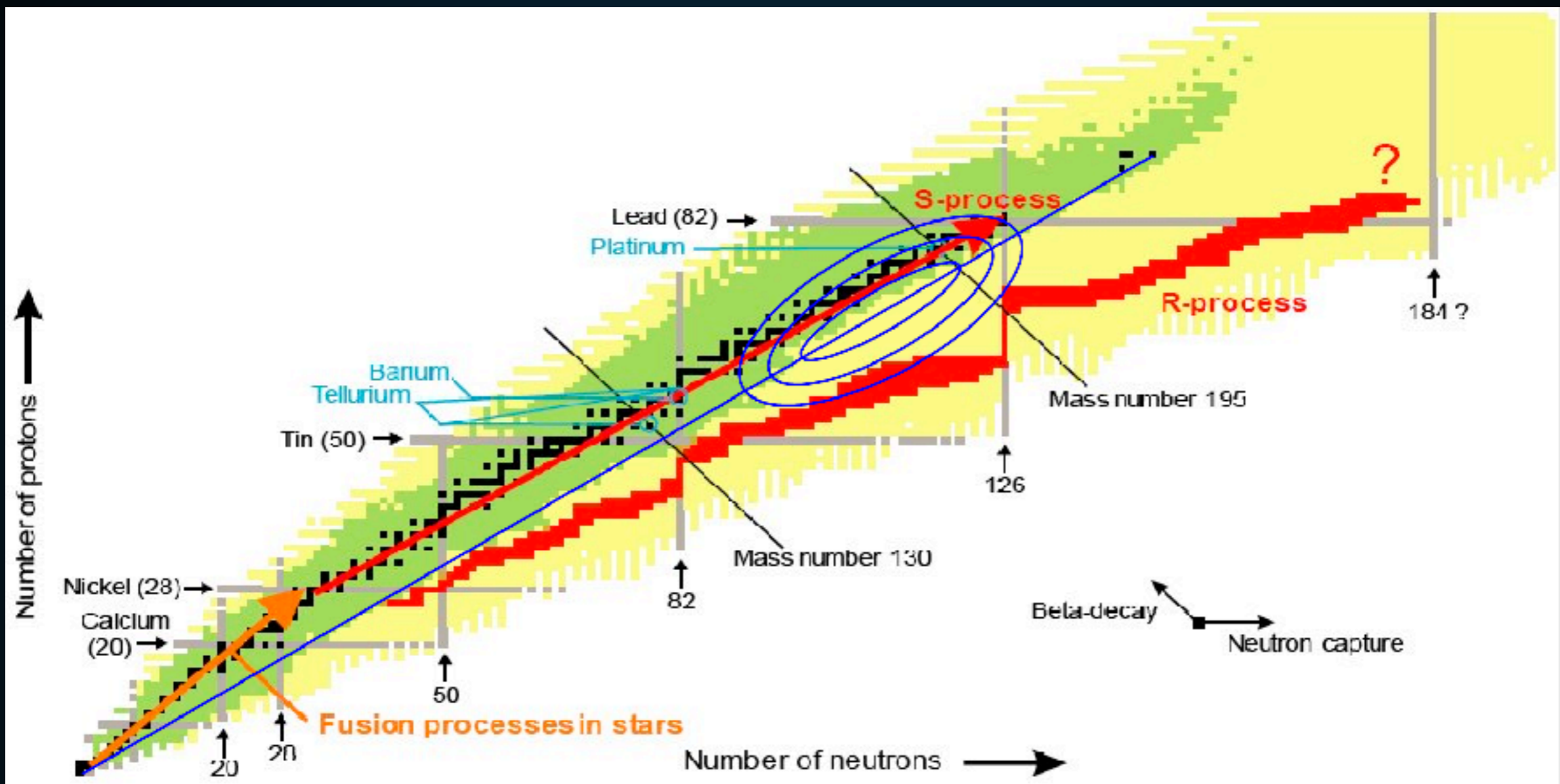

- ▶ Producing elements with large neutron over density requires extremely neutron-dense environment to avoid  $\beta$ -decay

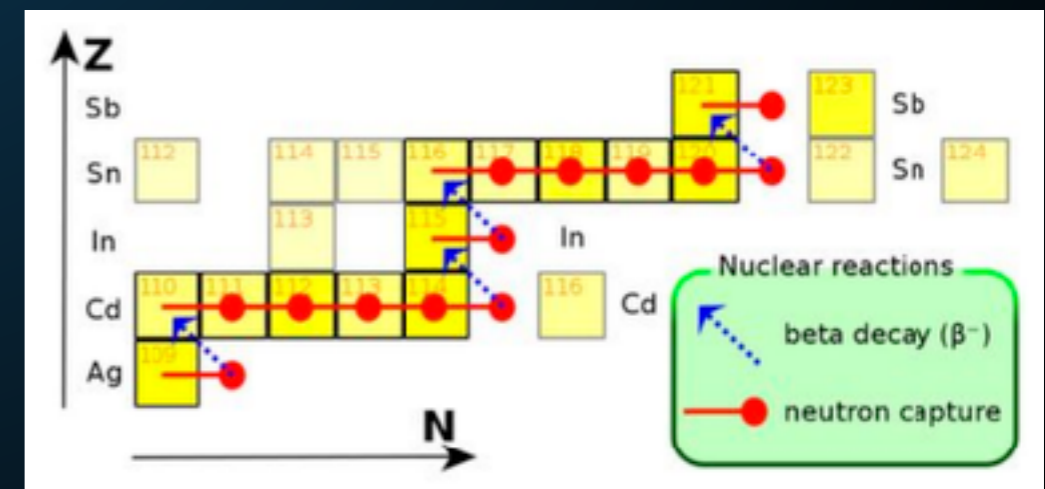

- ▶ FRB rates may be as high as  $10^5 \text{ day}^{-1}$ .
- ▶ Consistent with a galactic FRB rate of  $10^{-2} \text{ yr}^{-1}$  and with the SN rate.
- ▶ Consistent with the cross-sections needed to explain the missing pulsar problem.

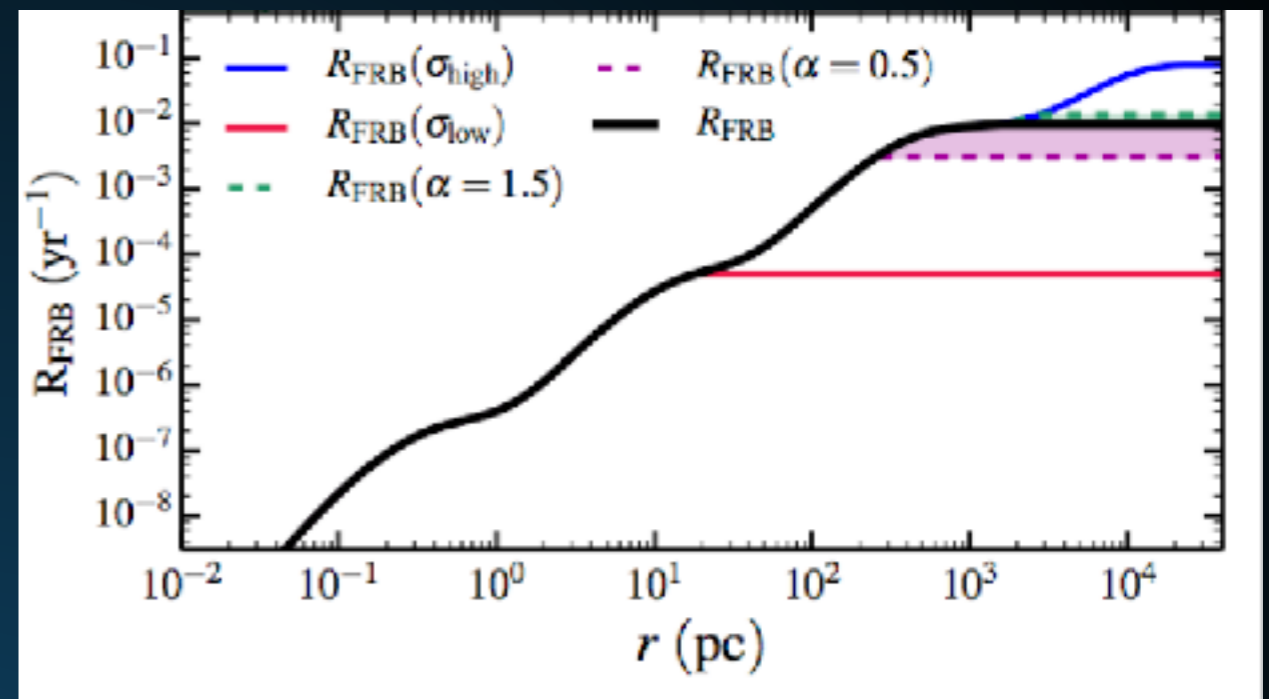

Bramante et al. (1706.00001)

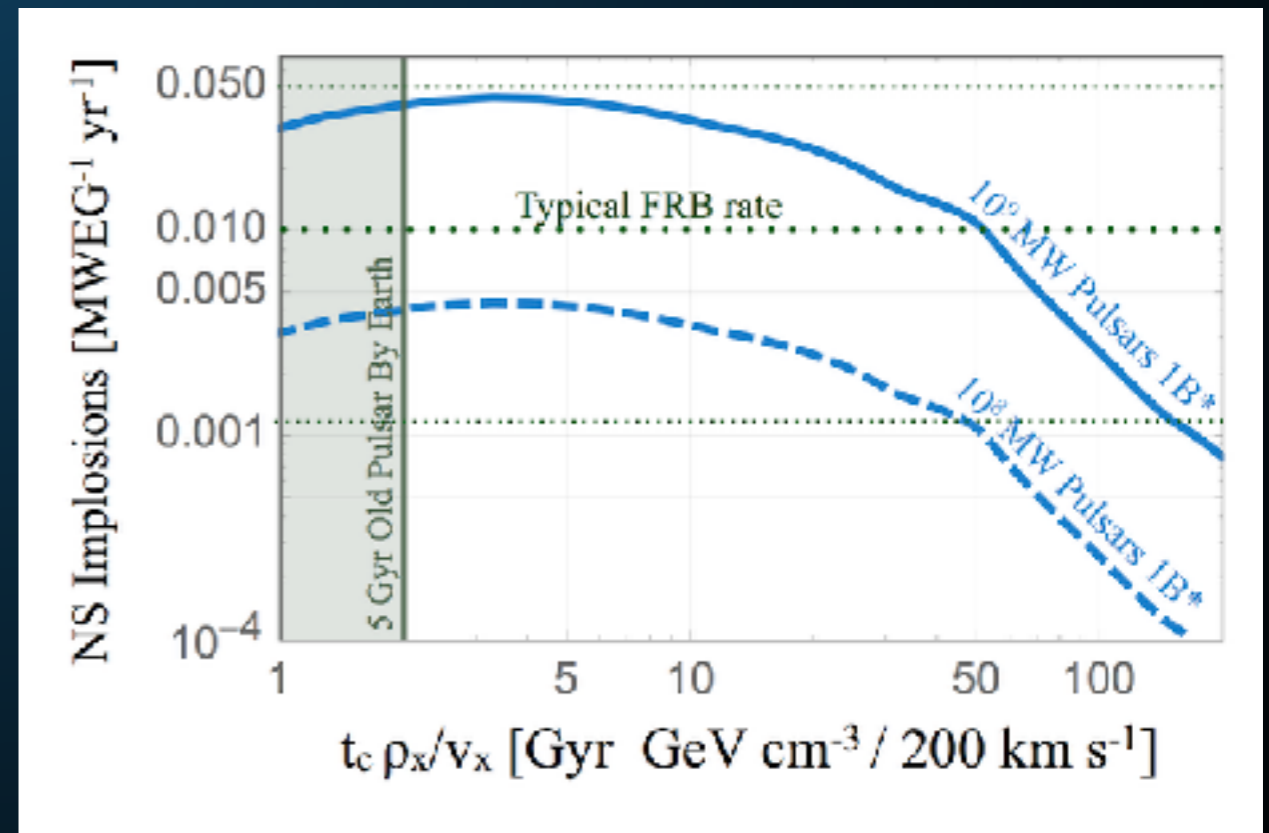

## HOWEVER, BINARY STELLAR EVOLUTION IS TRICKY

- ▶ Neutron stars receive large natal kicks due to asymmetries in the supernovae explosion.
- ▶  $v_{\text{kick}} \sim 400 \text{ km s}^{-1}$ .
- ▶ Escape velocity of dSph  $\sim 10 \text{ km s}^{-1}$ .
- ▶ Low kick neutron star populations are possible (e.g. globular clusters)

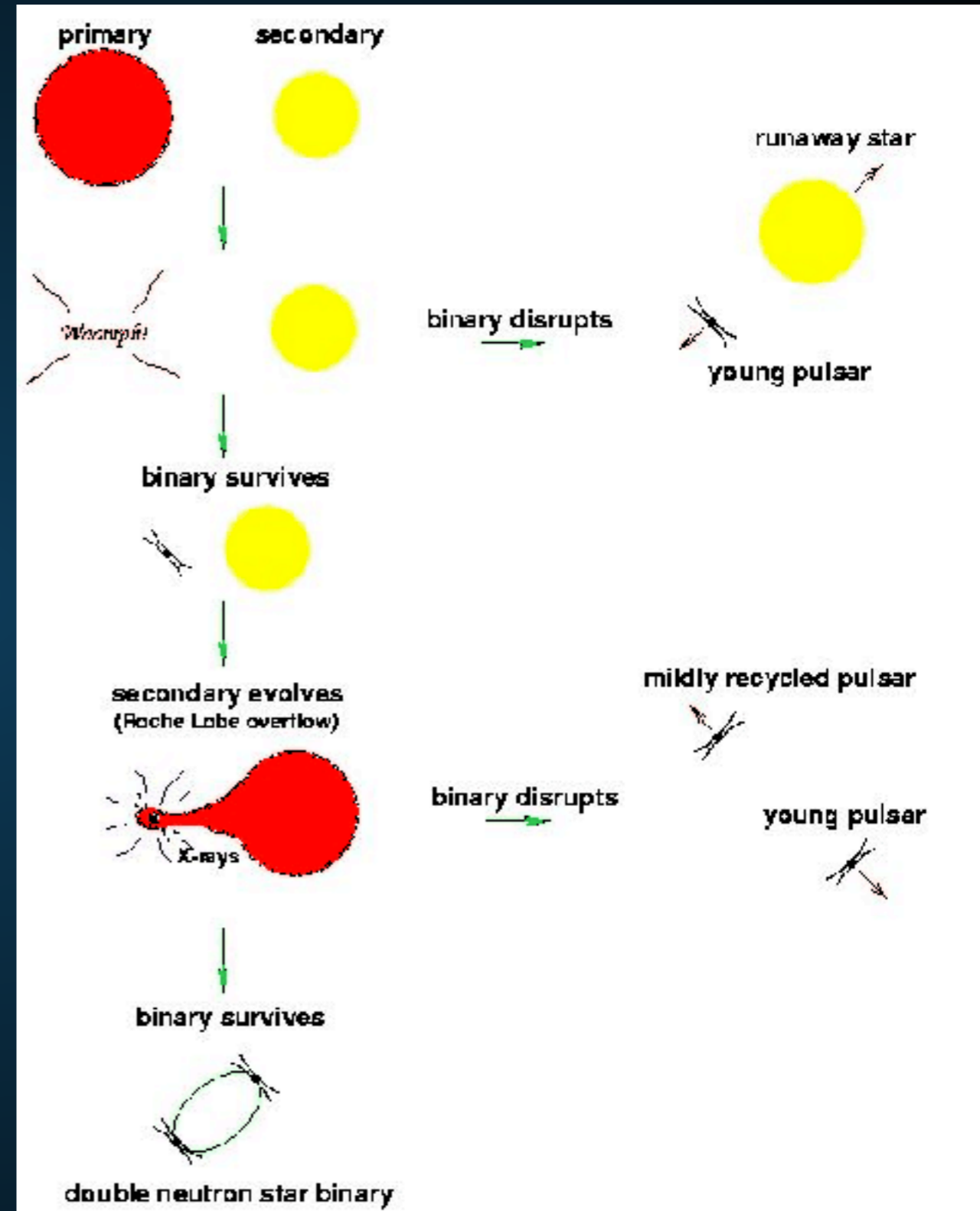



# R-PROCESS ENRICHMENT OF DWARF SPHEROIDAL GALAXIES

---

- ▶ Differentiating supernovae and neutron star binary mergers
- ▶ Supernovae are common:  
 $0.02 \text{ SN yr}^{-1}$  in Milky Way
- ▶ Neutron Star Mergers Rare:  
 $10^{-4} \text{ yr}^{-1}$  in Milky Way
- ▶ **But r-process yields for each unknown - degenerate with rate!**

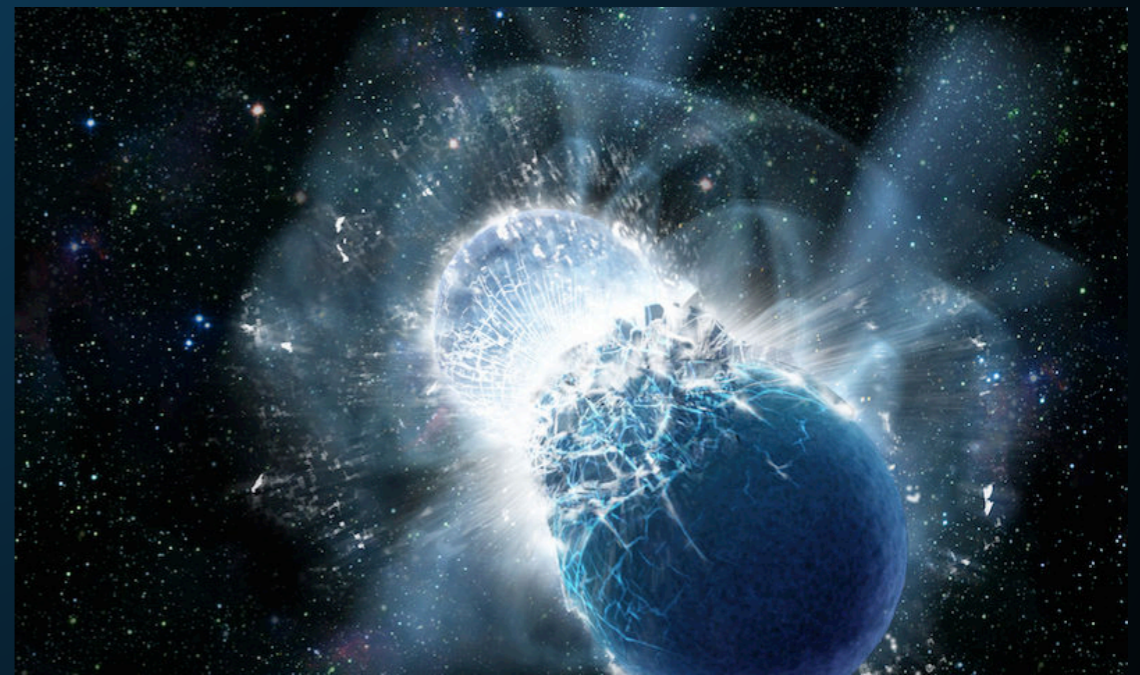
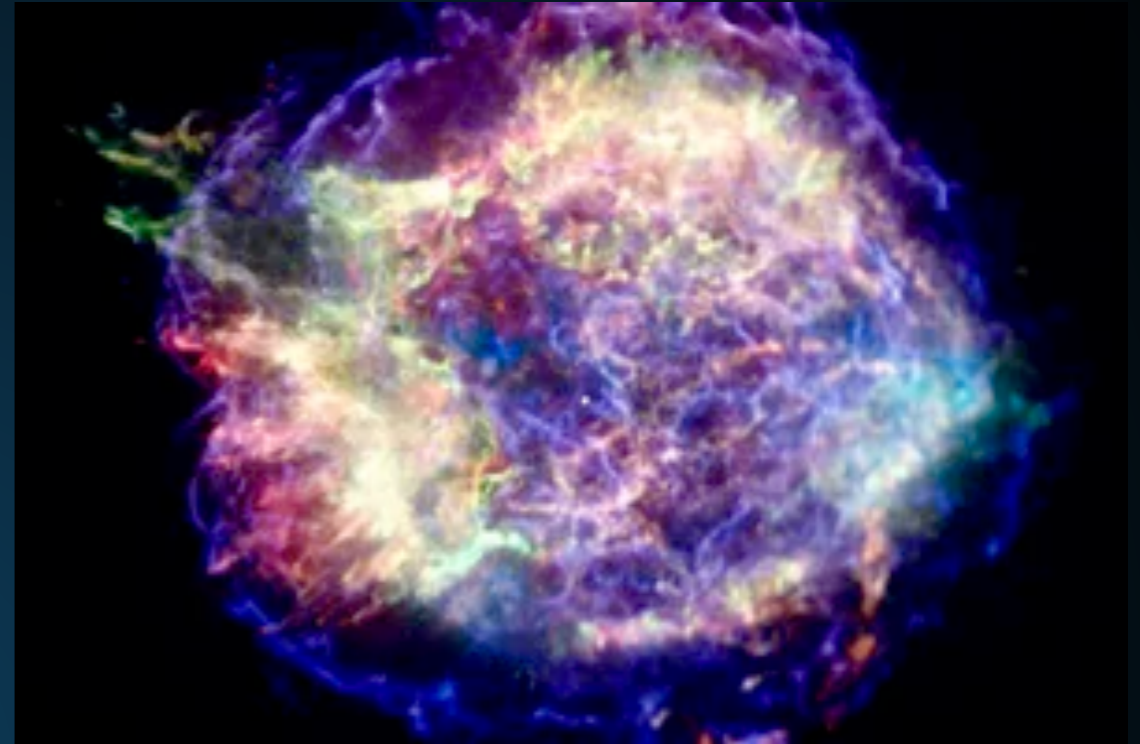

# Natal Kicks and Time Delays in Merging Neutron Star Binaries - Implications for $r$ -process nucleosynthesis in Ultra Faint Dwarfs and in the Milky Way

Paz Beniamini, Kenta Hotokezaka and Tsvi Piran

Racah Institute of Physics, The Hebrew University of Jerusalem, Jerusalem 91904, Israel

Received \_\_\_\_\_; accepted \_\_\_\_\_

$10^4$        $10^2$        $10^0$        $10^{-1}$   
Total Stellar Mass of UFDs ( $M_{\odot}$ )

- ▶ **Prediction: Globular Clusters should not be similarly r-process enriched.**

- ▶ **In fact, no globular cluster has been observed to have an r-process overabundance exceeding 1.2 dex.**

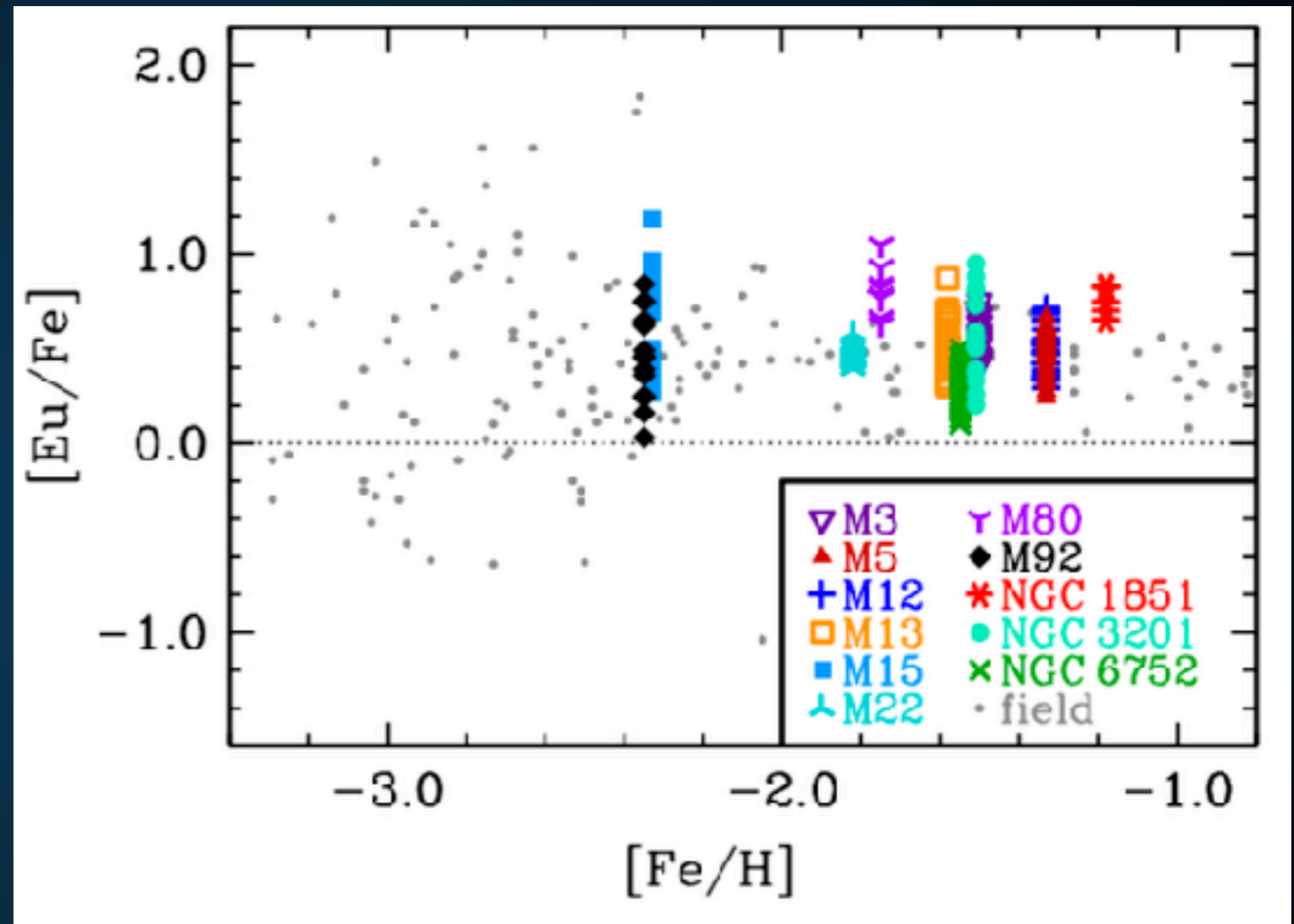

- ▶ **6 of 9 stars in Reticulum II have r-process enrichment exceeding 1.68 dex.**



## NEUTRON STAR COLLAPSE

---

- ▶ **Direct neutron star collapse occurs in regions with similar densities and magnetic fields.**
- ▶ **Can naively expect similar signals.**
- ▶ **Detailed models coming!**

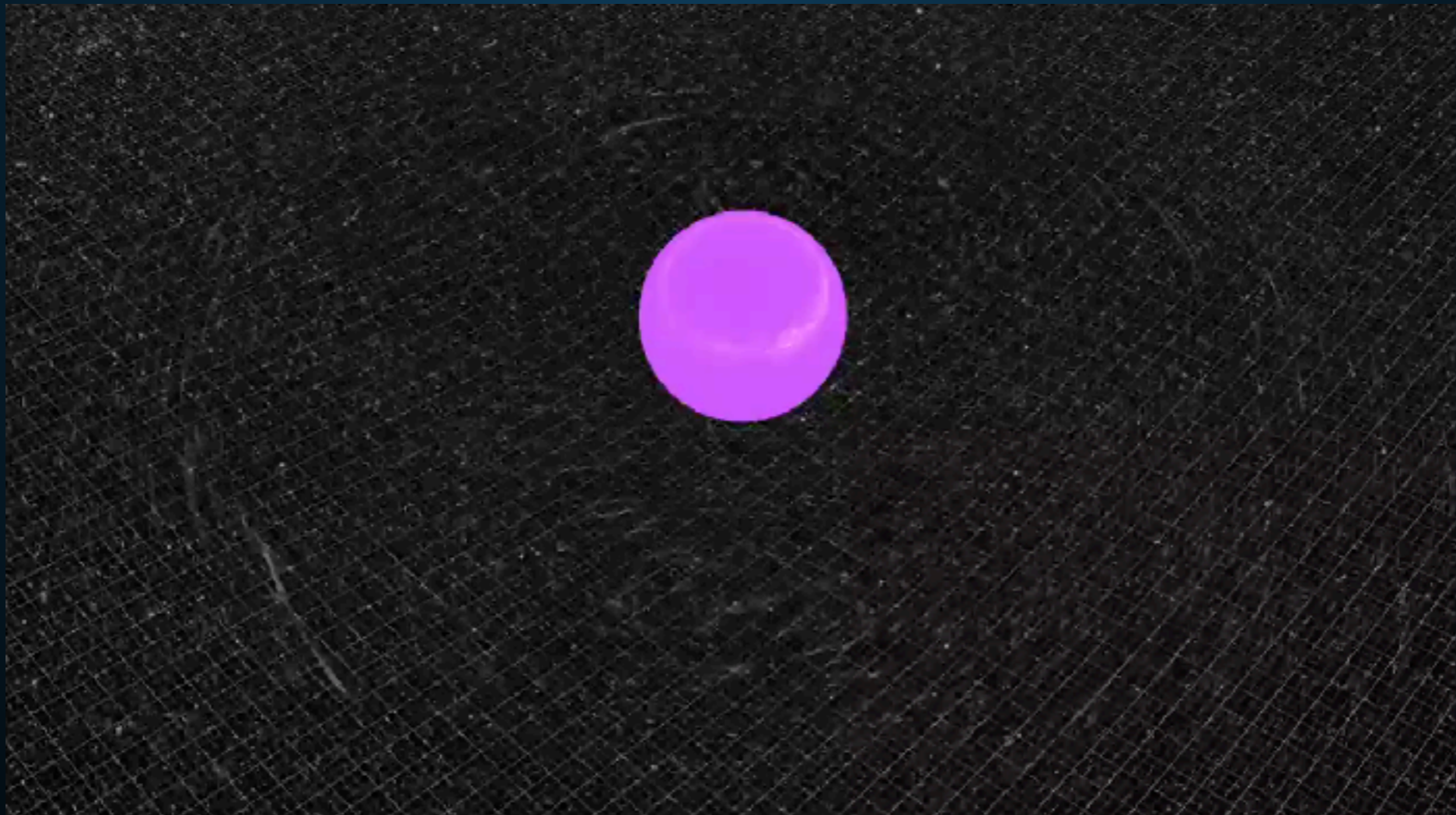

- ▶ **The escape velocity from a dwarf spheroidal galaxy is small:**

$$v_{esc} = 10.9 \left( \frac{M}{10^7 M_{\odot}} \right)^{1/3} \left[ \frac{1+z}{9.5} \right]^{1/2} \frac{\text{km}}{\text{s}}$$

- ▶ **Natal kicks remove >99% of all binaries from the dwarf spheroidal galaxy.**

-	10 Myr	50 Myr	100 Myr	500 Myr	1 Gyr	10 Gyr
10 km/s	<0.0001	<0.0001	<0.0001	0.0011	0.0016	0.0023
20 km/s	<0.0001	0.0004	0.0008	0.0085	0.0125	0.0183
50 km/s	<0.0001	0.0064	0.0136	0.0569	0.0801	0.1345
100 km/s	0.0002	0.0151	0.0378	0.1519	0.2202	0.4497



# PROBLEM: WE SEE OLD NEUTRON STARS

Bramante et al. (1310.3509)

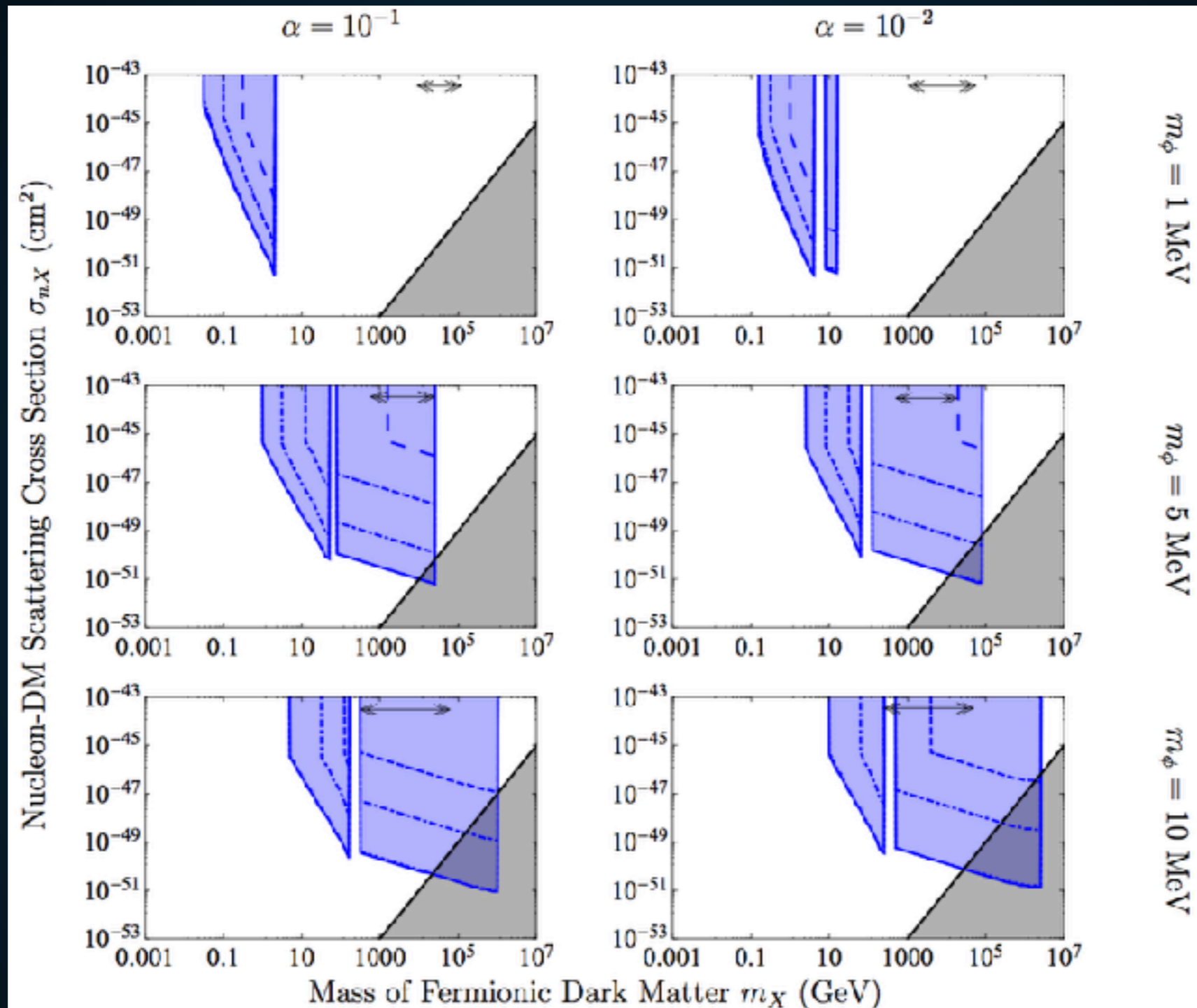

- Or Fermionic Dark matter with an attractive self-interaction cross-section.



# A USEFUL MEASUREMENT

$$M_{DM} \propto \sigma_{xp}$$

particle physics

$t_{NS}$

position dependent

$$\left( \frac{P_x}{V_x} \right)$$

in any p.p. model

$$t_{imp}(r) \propto \frac{P_x}{V_x}$$

can examine the morphology of these events!

▶ **Disassociation of electromagnetic and gravitational wave signatures**

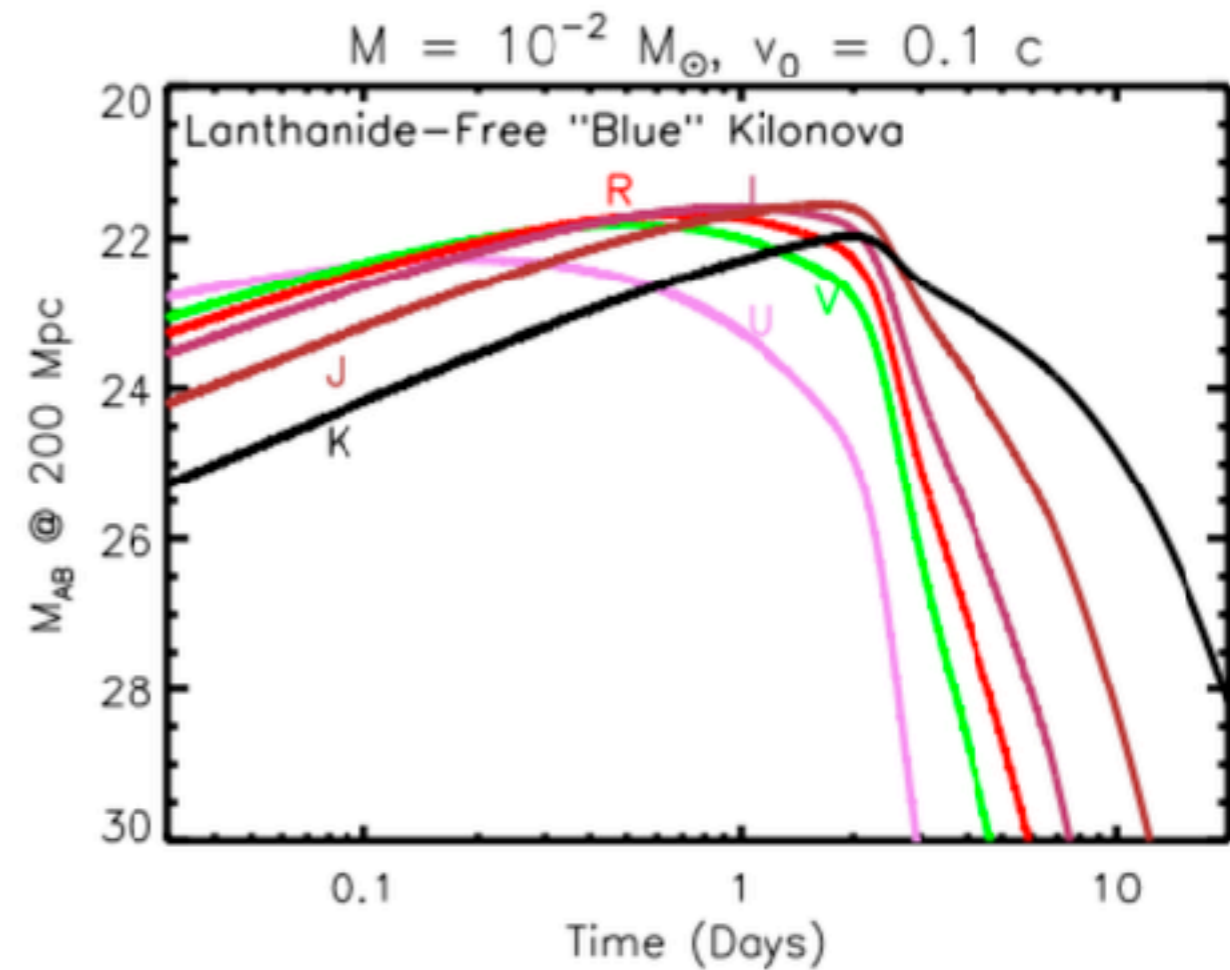
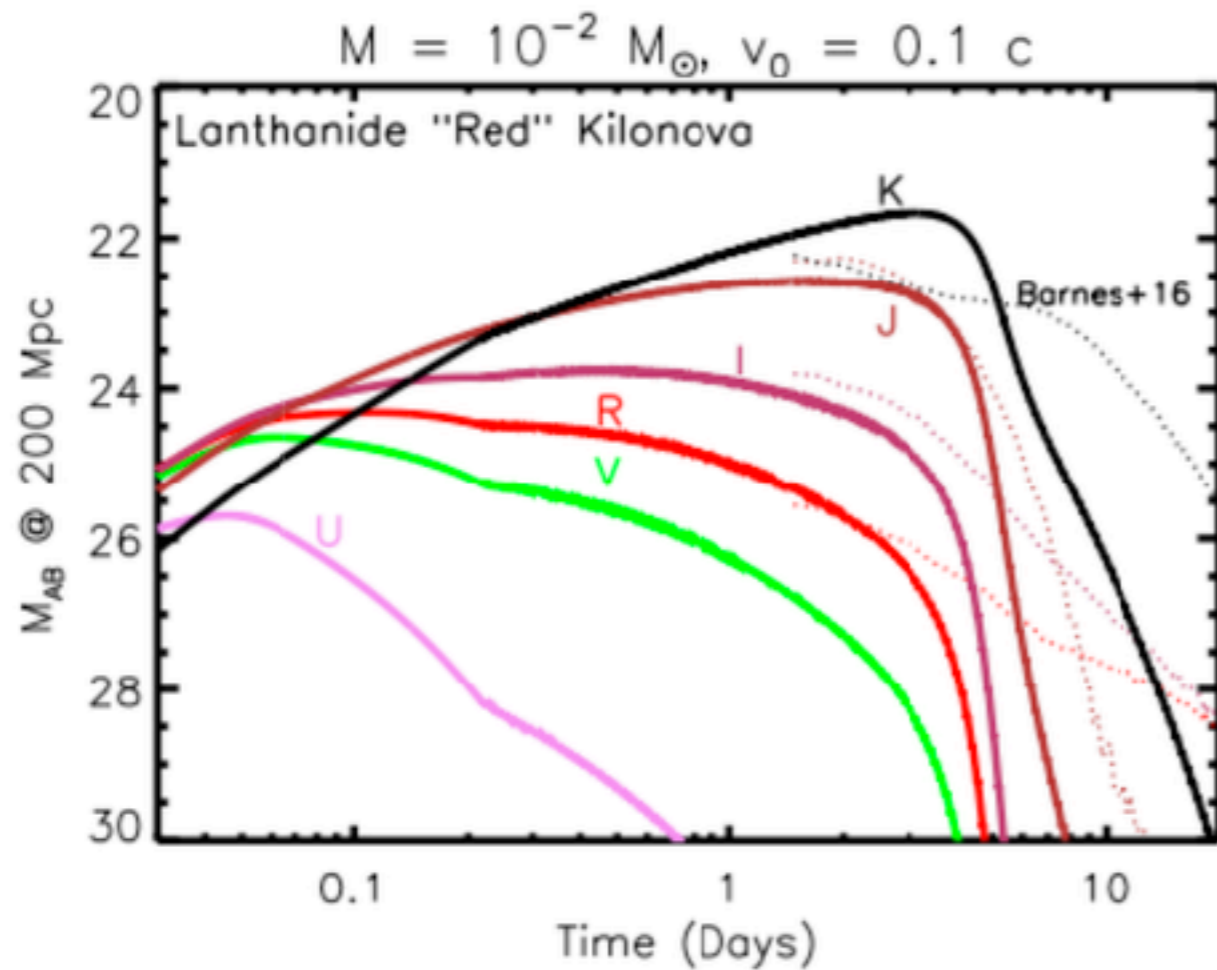

- ▶ Or can be found in transient events, such as *merger kilonovae* from neutron star mergers.



# ASYMMETRIC DARK MATTER CAN PRODUCE THESE SIGNALS

- ▶ FRB rates are consistent with a galactic FRB rate of  $10^{-2} \text{ yr}^{-1}$  and with the SN rate. (approximately SN rate).
- ▶ Dark Matter induced neutron star collapse can produce the nuclear densities required to produce r-process elements.

Bramante et al. (1706.00001)

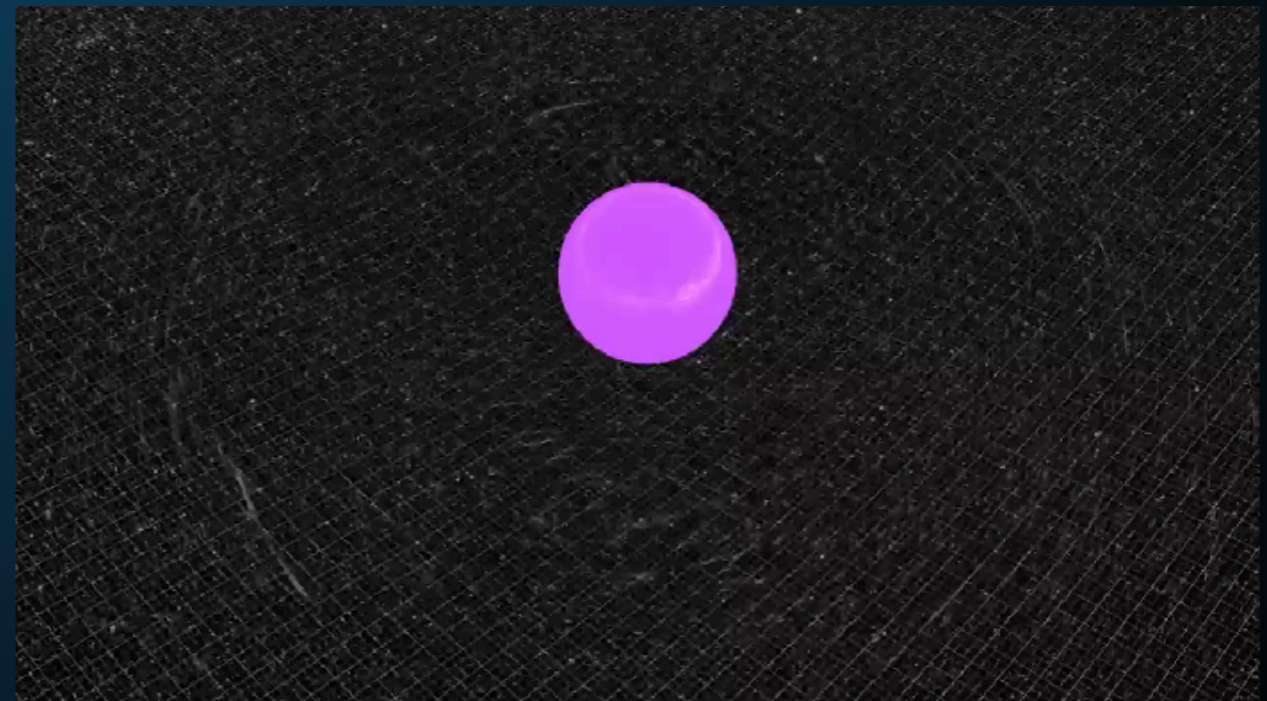
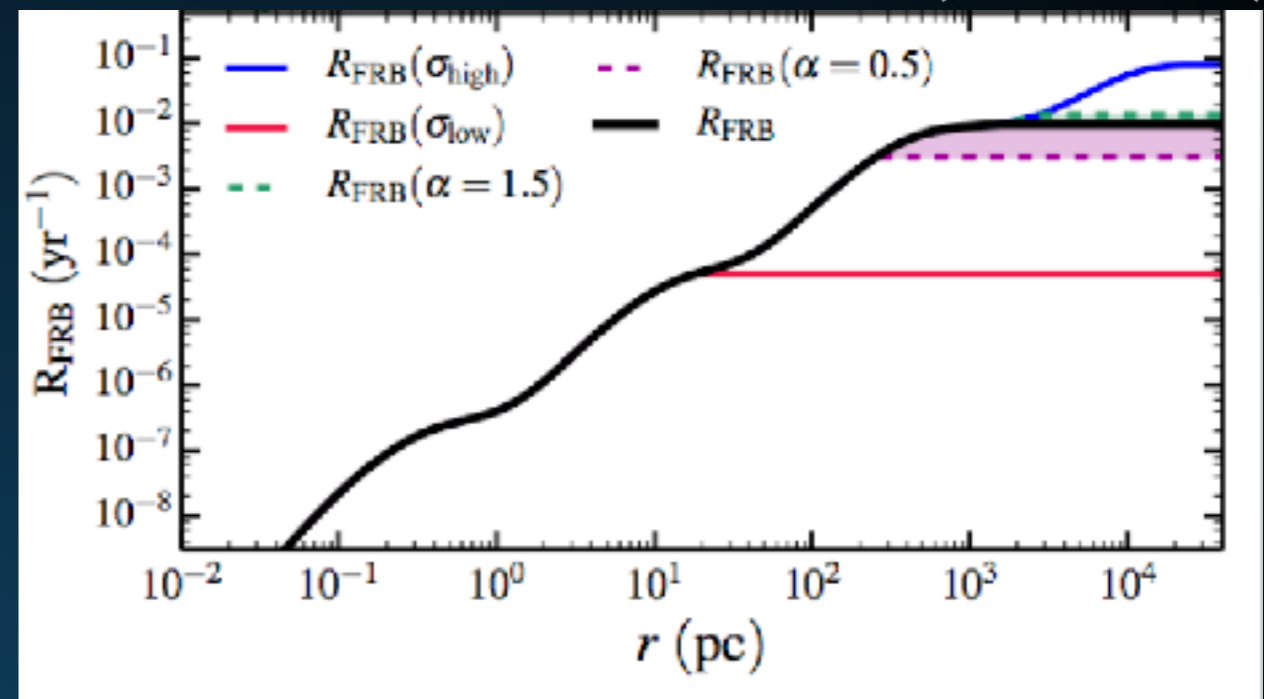



# FAST RADIO BURSTS

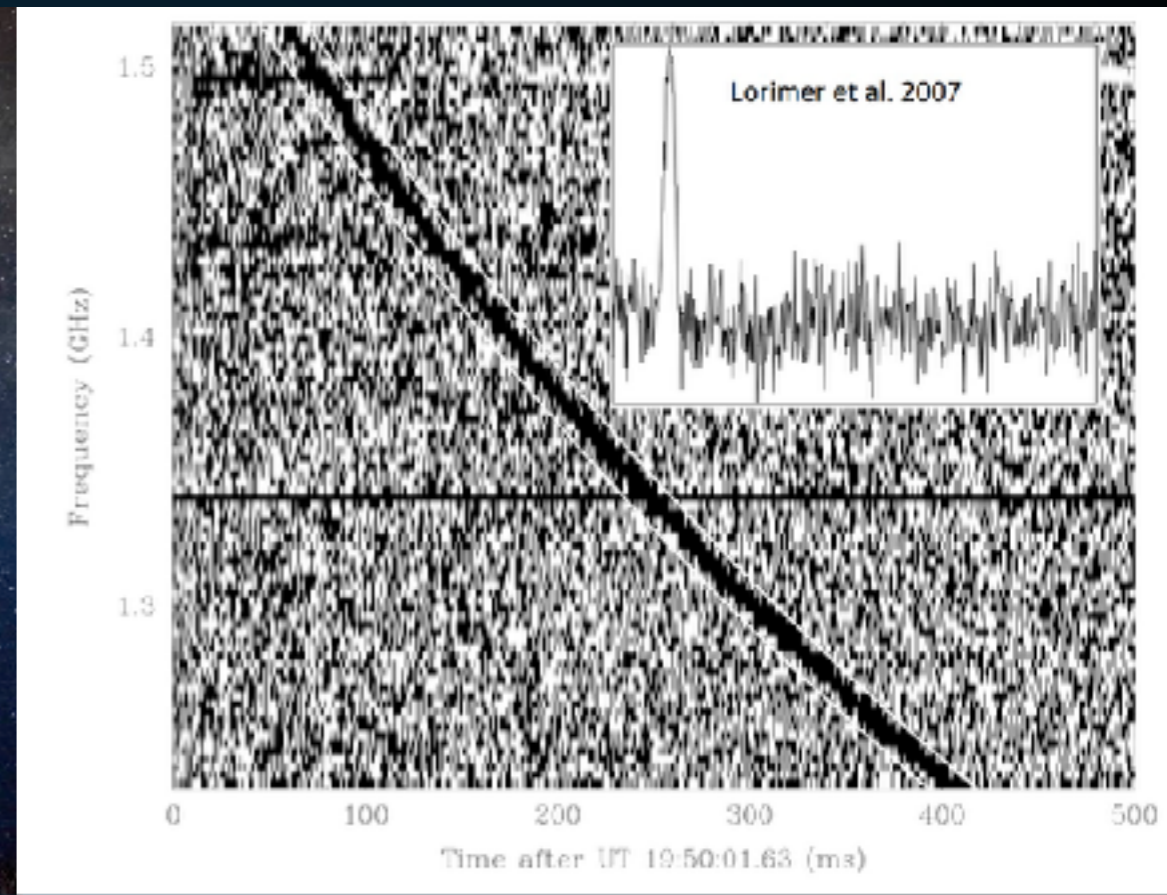
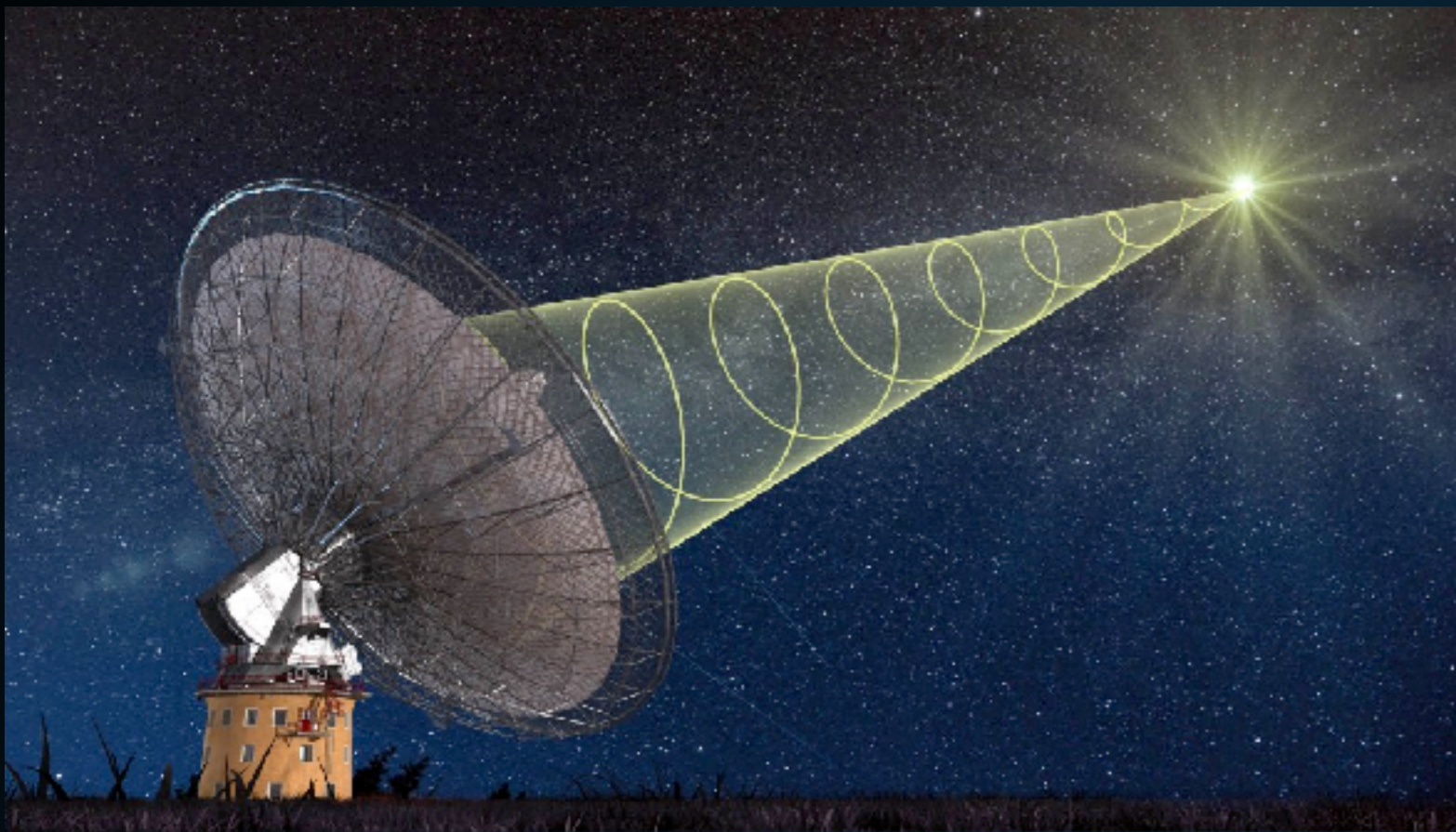

- ▶ Short ( $\sim$ ms) radio bursts first discovered in 2007
- ▶ High dispersion measure indicates extragalactic origin.
- ▶ One repeating fast radio bursts, but others appear not to repeat.
- ▶ Origin unknown.

- ▶ Millisecond timescale indicates  $r < 300$  km.
- ▶ Radio pulsar magnetic fields have necessary energetics and timescales.
- ▶ Models of NS mergers and accretion induced collapse have been produced.

